

Part number

# AP 0909



Box for control devices and signals, AC series, without cable entry, without holes, external dimensions 92x92x86 mm

#### Product description

<b>Product type</b>	Box for control devices and signals
<b>Series</b>	AC
<b>Size</b>	External dimensions 92x92x86 mm
<b>Specification</b>	Without cable entry Without holes

#### Technical data

**IP degree of protection** IP65

#### Further technical details

<b>Weight</b>	495,00 g
<b>Operating temperature range (min, max)</b>	-20°C ... +80°C

#### Material properties

<b>Main material</b>	Aluminium die-cast
<b>Other materials</b>	Gasket: NBR Screws: galvanized steel
<b>Colour</b>	RAL 7040 grey
<b>RoHs conformity</b>	Compliant with exemption 6(c): copper alloy containing up to 4% lead by weight
<b>China RoHs - EFUP</b>	50
<b>REACH SVHC substances</b>	Yes Lead
<b>SCIP number</b>	A4d990c2-7936-4d11-a722-eb8d5d39ca82

#### General ordering information

**EAN13 code** 8015747001274

#### Packaging Information

<b>Packaging length</b>	285,00 mm
<b>Packaging height</b>	200,00 mm
<b>Packaging width</b>	205,00 mm
<b>Packaging weight</b>	6,50 kg
<b>Packaging volume</b>	11,69 dm <sup>3</sup>
<b>Packaging description</b>	Carton box
<b>Packaging quantity</b>	12 Pcs
<b>Packaging EAN code</b>	8015747001281

Part number

# AP 0909



## Catalogue drawings

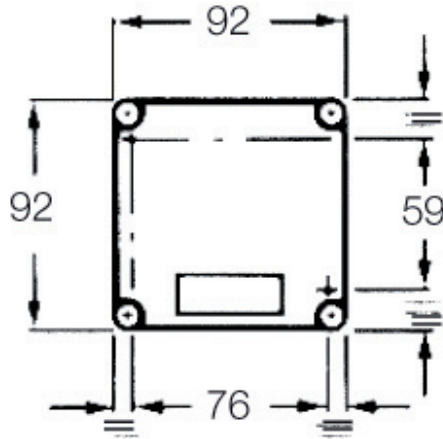

## Notes

### California Proposition 65 Information



### WARNING

This product can expose you to lead and its compounds, known to the State of California to cause cancer and/or reproductive toxicity. For more information go to [www.P65Warnings.ca.gov](http://www.P65Warnings.ca.gov).

Dimensions shown in mm are not binding and may be changed without notice.