



LUT9U-12306

LUT9

LUMINESCENCE SENSORS

SICK
Sensor Intelligence.



Illustration may differ



Ordering information

Type	Part no.
LUT9U-12306	1047055

Other models and accessories → www.sick.com/LUT9

Detailed technical data

Features

Dimensions (W x H x D)	30.4 mm x 53 mm x 80 mm
Sensing distance	50 mm ¹⁾
Housing design	Large
Working range	20 mm ... 70 mm
Light source	LED, UV ²⁾
Wave length	375 nm
Light emission	Long and short side, exchangeable
Light spot size	5 mm x 15 mm
Light spot direction	Vertical
Receiving filters	KV 418 (standard)
Receiving range	450 nm ... 750 nm
Adjustment	Teach-in button
Teach-in mode	Static 2-point teach-in with manual fine adjustment
Output function	Light switching ³⁾

¹⁾ From leading edge of lens.

²⁾ Average service life: 100,000 h at T_U = +25 °C.

³⁾ L/D switching via teach-in.

Mechanics/electronics

Supply voltage	10 V DC ... 30 V DC ¹⁾
Ripple	< 5 V _{pp} ²⁾

¹⁾ Limit values when operated in short-circuit protected network: max. 8 A.

²⁾ May not exceed or fall below U_v tolerances.

³⁾ Without load.

⁴⁾ With light/dark ratio 1:1, without timer stage.

⁵⁾ Signal transit time with resistive load.

⁶⁾ Reference voltage DC 50 V.

Current consumption	< 100 mA ³⁾
Switching frequency	0.5 kHz ⁴⁾ 2.5 kHz 6.5 kHz Adjustable
Response time	1 ms, 200 µs, 75 µs ⁵⁾
Switching output	PNP, NPN
Switching output (voltage)	PNP: HIGH = $U_V \leq 2\text{ V}$ / LOW approx. 0 V NPN: HIGH = approx. U_V / LOW $\leq 2\text{ V}$
Switching mode	Light switching
Analog output	0 mA ... 13 mA
Output current I_{\max}	100 mA
Time delay	Switch-off delay, 0 ms / 10 ms / 20 ms, adjustable (0 ms = default)
Connection type	Male connector M12, 5-pin
Protection class	II ⁶⁾
Circuit protection	U_V connections, reverse polarity protected Output Q short-circuit protected Interference pulse suppression
Enclosure rating	IP67
Weight	400 g
Housing material	Metal, zinc diecast

1) Limit values when operated in short-circuit protected network: max. 8 A.

2) May not exceed or fall below U_V tolerances.

3) Without load.

4) With light/dark ratio 1:1, without timer stage.

5) Signal transit time with resistive load.

6) Reference voltage DC 50 V.

Ambient data

Ambient operating temperature	-10 °C ... +55 °C
Ambient temperature, storage	-25 °C ... +75 °C
Shock load	According to IEC 60068

Classifications

ECLASS 5.0	27270908
ECLASS 5.1.4	27270908
ECLASS 6.0	27270908
ECLASS 6.2	27270908
ECLASS 7.0	27270908
ECLASS 8.0	27270908
ECLASS 8.1	27270908
ECLASS 9.0	27270908
ECLASS 10.0	27270908
ECLASS 11.0	27270908
ECLASS 12.0	27270908
ETIM 5.0	EC001822

ETIM 6.0	EC001822
ETIM 7.0	EC001822
ETIM 8.0	EC001822
UNSPSC 16.0901	39121528

Dimensional drawing (Dimensions in mm (inch))

LUT9x-x2xxx, light emission: long and short side, exchangeable

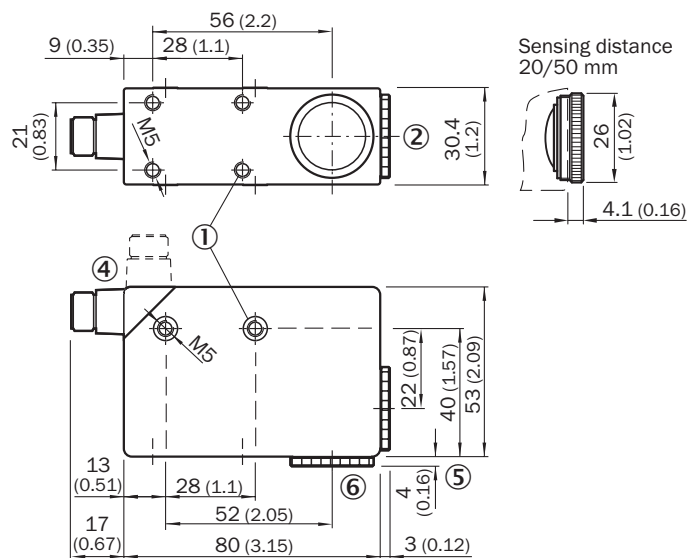

- ① M5 threaded mounting hole, 5.5 mm deep
- ② Lens (light transmission), can be replaced by blind screw
- ④ Connector M12 (rotatable up to 90°)
- ⑤ See dimensional drawings of lenses
- ⑥ Blind screw can be replaced by lens

Adjustments

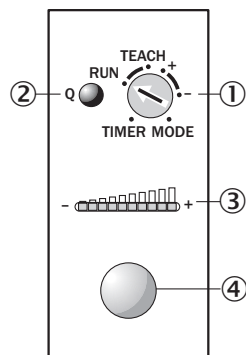

- ① Rotary selection switch
- ② Function signal indicator (yellow), switching output
- ③ Bar graph (green), power-on left-hand LED
- ④ Teach-in button

Connection diagram

Cd-312

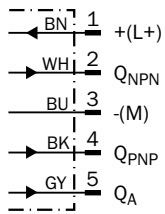

Concept of operation

Teach-in static

1. Position mark

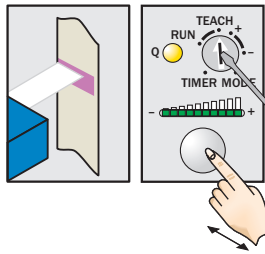

Turn rotary switch to "TEACH" position and press and hold teach-in button > 1 s. Yellow LED flashes slowly.

2. Position background

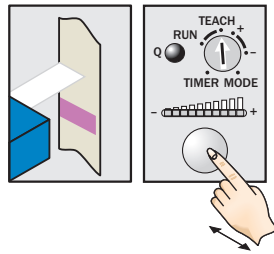

Press and hold teach-in button again > 1 s. Yellow LED goes out.

Sensitivity setting

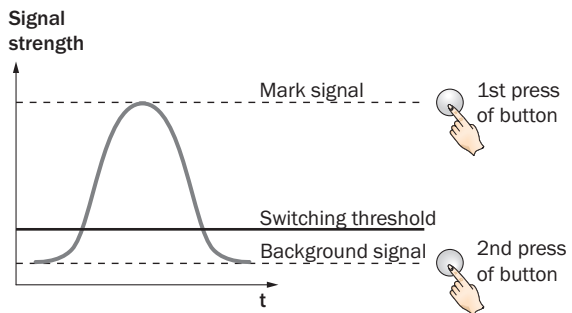

Note

The bar graph display shows detection reliability. The more LEDs that illuminate, the better the teach-in.

Button +/-

1. Position mark

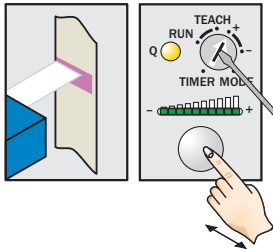

Turn rotary switch to “+” position and press and hold teach-in button until yellow light goes out (more green LEDs illuminate on the bar display).

2. Position background

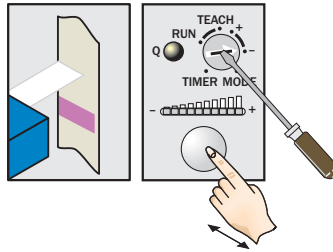

If yellow LED illuminates, turn rotary switch to “-” position and press and hold teach-in button until yellow light just goes out (green LEDs go out on the bar display).

Sensitivity setting

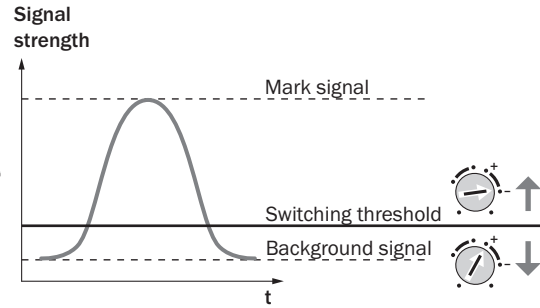

Note for all settings

Once configuration is complete, turn the rotary switch to the “RUN” position. The bar display then shows the luminescence intensity (regardless of switching threshold setting).

Adjustments are intended for luminescence background suppression.

Sensing distance

Sensing distance

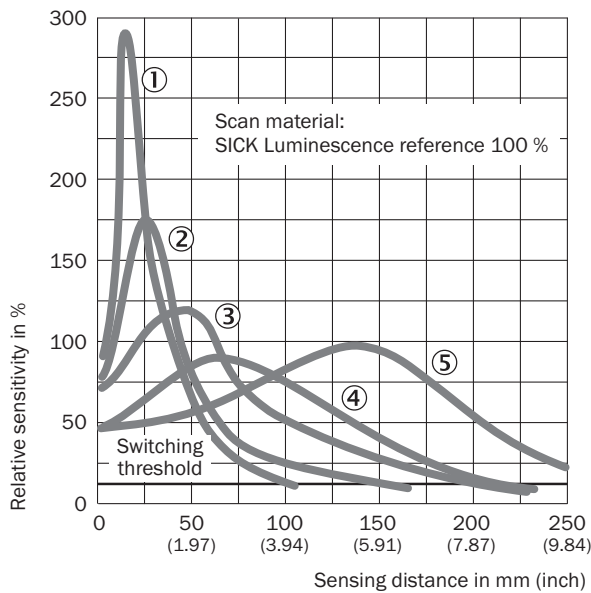

- ① Sensing distance 10 mm
- ② Sensing distance 20 mm
- ③ Sensing distance 50 mm
- ④ Sensing distance 90 mm
- ⑤ Sensing distance 150 mm

Light spot size

Light spot size

Sensing distance 10 mm

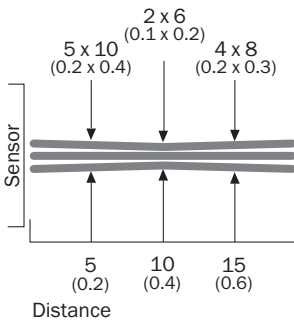

Sensing distance 20 mm

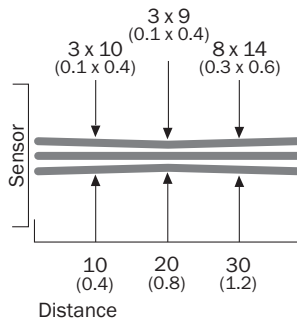

Sensing distance 50 mm

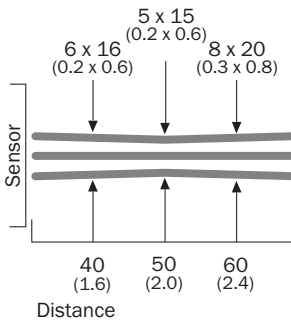

Sensing distance 90 mm

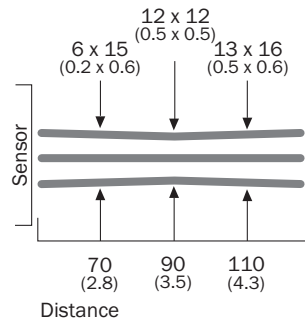

Sensing distance 150 mm

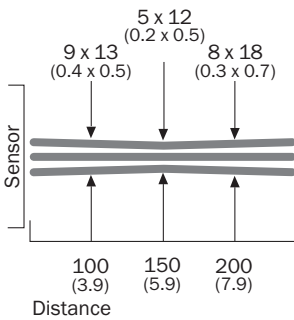













All dimensions in mm (inch)

Recommended accessories

Other models and accessories → www.sick.com/LUT9

	Brief description	Type	Part no.
Lenses and accessories			
	Lens, 90 mm scanning distance, M20 x 0.75	OBJ-026	1001326
	Lens, 10 mm sensing distance, M25 x 0.75	OBJ-LUT3-10	2016348
	Lens, 20 mm sensing distance, M25 x 0.75	OBJ-LUT3-20	2016349
	Lens, 50 mm sensing distance, M25 x 0.75	OBJ-LUT3-50	2016350
Universal bar clamp systems			
		BEF-KHS-G01	2022464
		BEF-KHS-K01	2022718

	Brief description	Type	Part no.
		BEF-KHS-KH1	2022726
		BEF-MS12G-A	4056054
		BEF-MS12G-B	4056055
		BEF-MS12L-A	4056052
		BEF-MS12L-B	4056053
Plug connectors and cables			
		YF2A15-020VB5XLEAX	2096239
		YF2A15-050VB5XLEAX	2096240
		YF2A15-100VB5XLEAX	2096241
		YG2A15-020VB5XLEAX	2096215
		YG2A15-050VB5XLEAX	2096216
		YG2A15-100VB5XLEAX	2096217
		DOS-1205-G	6009719
		DOS-1205-W	6009720

SICK AT A GLANCE

SICK is one of the leading manufacturers of intelligent sensors and sensor solutions for industrial applications. A unique range of products and services creates the perfect basis for controlling processes securely and efficiently, protecting individuals from accidents and preventing damage to the environment.

We have extensive experience in a wide range of industries and understand their processes and requirements. With intelligent sensors, we can deliver exactly what our customers need. In application centers in Europe, Asia and North America, system solutions are tested and optimized in accordance with customer specifications. All this makes us a reliable supplier and development partner.

Comprehensive services complete our offering: SICK LifeTime Services provide support throughout the machine life cycle and ensure safety and productivity.

For us, that is “Sensor Intelligence.”

WORLDWIDE PRESENCE:

Contacts and other locations –www.sick.com