



Product designation	Solid state relay
Product type designation	HS1C
Type	single-phase

#### Input characteristics

Control voltage	3...32VDC
Operating voltage limits	
	Operating voltage pick-up V 3
	Operating voltage drop-out V 2
Input current at min...max voltage	mA 3...32VDC

#### Operating times

Switching-on	Half cycle max
Switching-off	Half cycle max

#### Output characteristics

Switching mode	Zero crossing
Rated operating voltage	VAC 12...275
Blocking voltage	V 600
Operational frequency (min...max)	Hz 45...65
Rated operating current AC-51 (resistive load) at 40°C	A 20
Rated operating current AC-51 (resistive load) at 55°C	A 17
Operational current min	A 0.165
Non repetitive surge peak on state current t=10ms	A 400
Off state leakage current	mA 1
On state output voltage drop	V 1.2
Critical rate of rise of off-state voltage dv/dt	V/μs 500
Input - Output isolation	V 5000
Input - Output to metal base	V 5000
Output protection type	VDR
I <sup>2</sup> t	A2s 792

#### Terminal characteristics

Control terminals	Type	Screw
Terminals tool		Blade 3.5mm
Tightening torque control terminals	Nm	0.5Nm
	Ibin	4.5
Conductor section connectable (control terminals) with 1 or 2 wires min...max		
	AWG stranded	n° 28...12
	Flexible w/o lug	mm <sup>2</sup> 0.75...2.5
	Flexible c/w insulated spade lug	mm <sup>2</sup> 0.75...2.5
Load terminals	Type	Screw
Load terminals tool		PH2
Tightening torque load terminals	Nm	1.5
	Ibin	13.3
Conductor section connectable (load terminals) with 1 or 2 wires min...max		
	AWG stranded	n° 18...10

Flexible w/o lug	mm <sup>2</sup>	1...6
Flexible c/w insulated spade lug	mm <sup>2</sup>	1...16

Operating position	allowable	On vertical plane
Fixing		Screw or on 35mm DIN rail

**Ambient conditions**

Temperature	Operating temperature	min	°C	-40
		max	°C	+80
	Storage temperature	min	°C	-40
		max	°C	+130

**Dimensions**

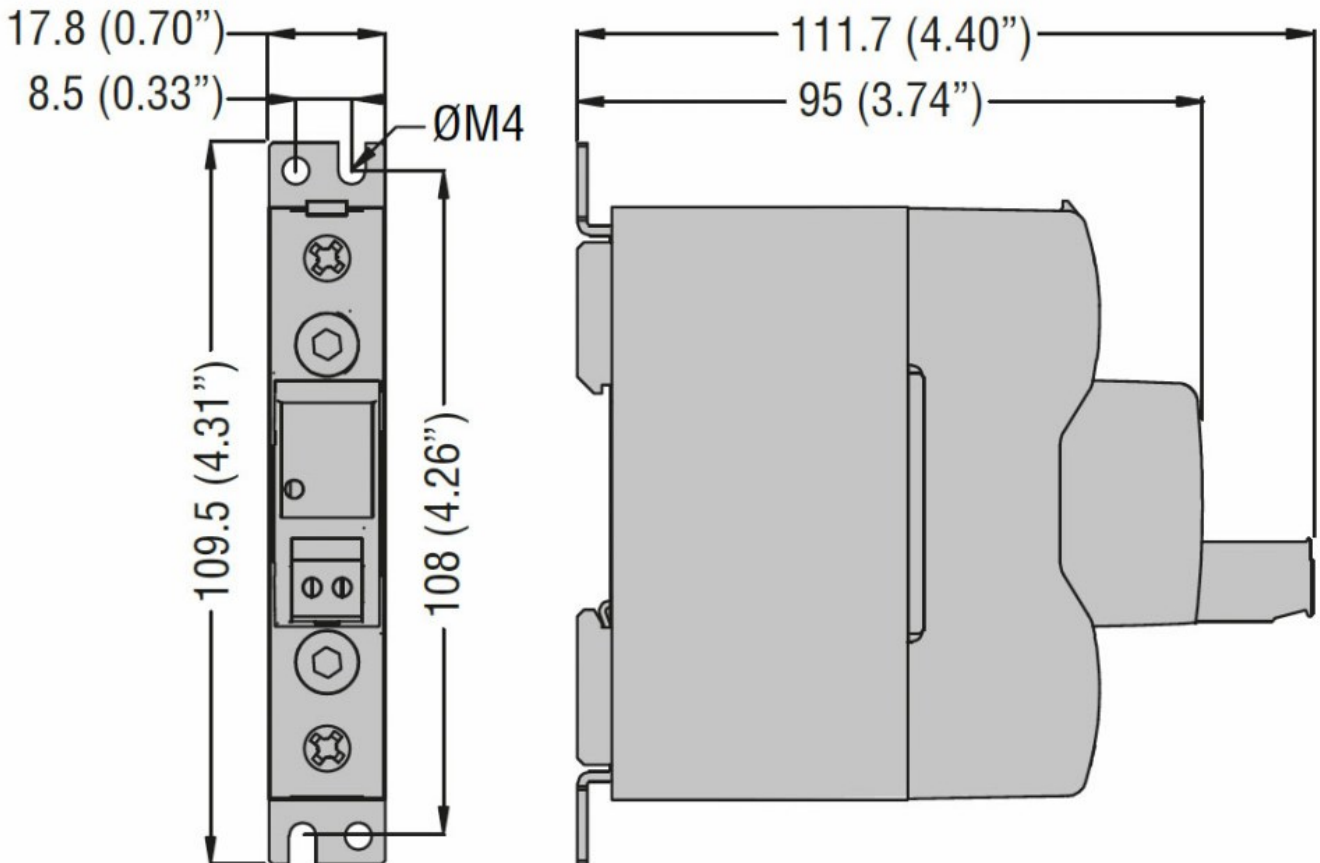

**Certifications and compliance**

Certifications	IEC/EN/BS 60947-4-2
	IEC/EN/BS 60947-4-3
	IEC/EN/BS 62314
	IEC/EN/BS 6335-1

Compliance	cULus
------------	-------

**ETIM classification**

EC000066 - Power contactor, AC switching