

**DEHNguard modular DG M TNC 275 (FM)**

**DG M TNS 275 (FM) DG M TT 275 (FM)**

- DE Einbauanleitung
- GB Installation instructions
- IT Istruzioni di montaggio
- FR Instructions de montage
- NL Montagehandleiding
- ES Instrucciones de montaje
- PT Instruções de montagem
- DK Monteringsvejledning
- SE Monteringsanvisning
- FI Asennusohje
- GR Οδηγίες συναρμολόγησης
- PL Instrukcja montażu
- CZ Montážní návod
- TR Kurulum Talimatları
- RU Инструкция по монтажу
- CN 安装说明
- HU Szerelési útmutató
- JP 設置説明書

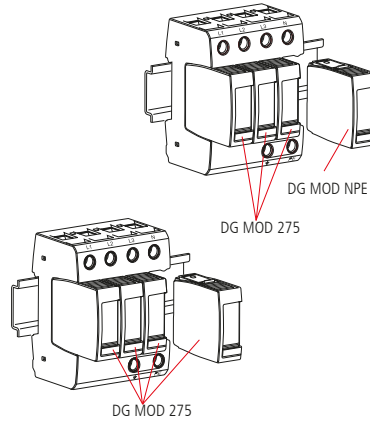
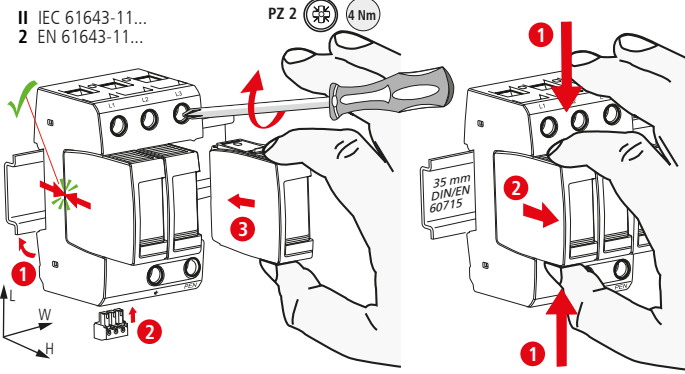

	DG M TNC 275 (FM)	DG M TNS 275 (FM)	L-N	DG M TT 275 (FM)
U <sub>N</sub> / Tol: ±10%	DG MOD 275			DG MOD NPE
U <sub>c</sub>	275 V~		230 / 400 V;	255 V
f <sub>N</sub>	125 A gG		50 / 60 Hz	---
I <sub>SCCR</sub>	50 kArms			---
I <sub>th</sub>	---			100 Arms
I <sub>max</sub>	40 kA			---
θ°	-40°C ... + 80°C			---
φ	5% ... 95%			---
I <sub>PE</sub>	< 0,15 mA			< 5 μA
IP *)	20			---
L x W x H	90 mm x 54 mm x 73 mm	90 mm x 72 mm x 73 mm		---

  

min. □ L, N, PE(N), ⊥	12 mm	12 mm	12 mm
max. □ L, N, PE(N), ⊥	25 mm <sup>2</sup>	1.5 mm <sup>2</sup>	35 mm <sup>2</sup>
□ ⚠	16 mm <sup>2</sup> Cu		≥15.5 mm

**TN-C DG M TNC 275 (FM)**

**TN (-C) -S DG M TNS 275 (FM)**

**TT DG M TT 275 (FM)**

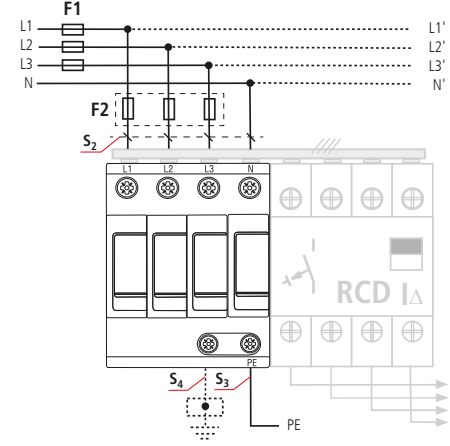
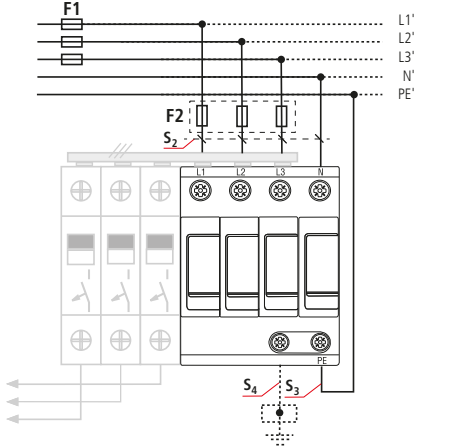
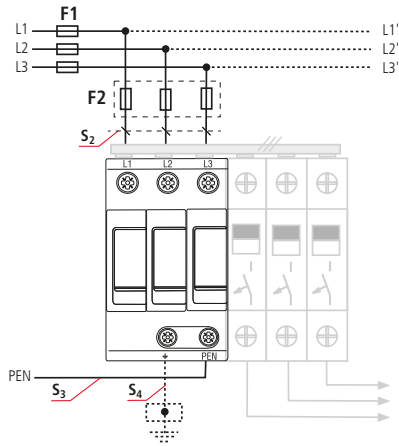

DEHNguard modular DG M TNC 275 (FM), DG M TNS 275 (FM), DG M TT 275 (FM)		DEHNguard modular DG M TNC 275 (FM), DG M TNS 275 (FM), DG M TT 275 (FM)				
F1	F2	F1 A gG	S <sub>2</sub> / mm <sup>2</sup>	S <sub>3</sub> / mm <sup>2</sup>	S <sub>4</sub> / mm <sup>2</sup>	F2 A gG
<div style="text-align: center;">                       F1 ≤ 125 A gG                      ↓                      F1 &gt; 125 A gG                      ↓                      F2 ≤ 125 A gG                 </div>	<div style="text-align: center;">                       F2 ≤ 125 A gG                 </div>	25	4	6	6	---
		35	4	6	6	---
		40	4	6	6	---
		50	6	6	6	---
		63	10	10	10	---
		80	10	10	10	---
		100	16	16	16	---
		125	16	16	16	---
		> 125	16	16	16	125

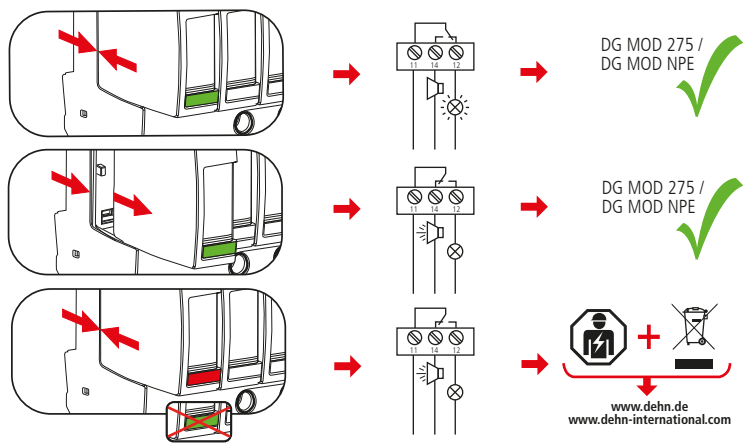
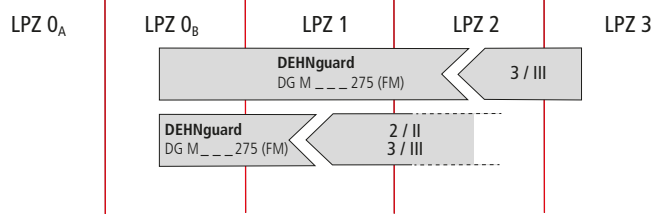

DEHNguard modular DG M TNC 275 FM, DG M TNS 275 FM, DG M TT 275 FM	
 U <sub>N</sub> / I <sub>N</sub>	AC: 250 V / 0.5 A DC: 250 V / 0.1 A 125 V / 0.2 A 75 V / 0.5 A
max. 1.5 mm <sup>2</sup>	

