



VL180-2P42431

V180-2

CYLINDRICAL PHOTOELECTRIC SENSORS

SICK
Sensor Intelligence.



Illustration may differ



Ordering information

Type	Part no.
VL180-2P42431	6041819

Included in delivery: P250 (1)

Other models and accessories → www.sick.com/V180-2

Detailed technical data

Features

Functional principle	Photoelectric retro-reflective sensor
Functional principle detail	Dual lens
Dimensions (W x H x D)	18 mm x 18 mm x 70.2 mm
Housing design (light emission)	Cylindrical
Housing length	70.2 mm
Thread diameter (housing)	M18 x 1
Optical axis	Axial
Sensing range max.	0.05 m ... 7 m ¹⁾
Sensing range	0.05 m ... 6 m ¹⁾
Focus	Approx. 4.5°
Type of light	Visible red light
Light source	LED ²⁾
Light spot size (distance)	Ø 400 mm (6 m)
Angle of dispersion	Approx. 4.5°
Wave length	645 nm
Adjustment	Potentiometer, 270° (Sensitivity)

¹⁾ Reflector PL80A.

²⁾ Average service life: 100,000 h at T_J = +25 °C.

Mechanics/electronics

Supply voltage	10 V DC ... 30 V DC ¹⁾
-----------------------	-----------------------------------

¹⁾ Limit values when operated in short-circuit protected network: max. 8 A.

²⁾ May not exceed or fall below U_V tolerances.

³⁾ Without load.

⁴⁾ Control wire open: dark switching D.ON.

⁵⁾ Signal transit time with resistive load.

⁶⁾ With light/dark ratio 1:1.

⁷⁾ A = V_S connections reverse-polarity protected.

⁸⁾ B = inputs and output reverse-polarity protected.

⁹⁾ D = outputs overcurrent and short-circuit protected.

Ripple	± 10 % ²⁾
Current consumption	30 mA ³⁾
Switching output	PNP ⁴⁾
Switching mode	Light/dark switching ⁴⁾
Switching mode selector	Selectable via L/D control cable
Signal voltage PNP HIGH/LOW	Approx. $V_S - 1.8 \text{ V} / 0 \text{ V}$
Output current I_{\max}	≤ 100 mA
Response time	≤ 0.5 ms ⁵⁾
Switching frequency	1,000 Hz ⁶⁾
Connection type	Male connector M12, 4-pin
Circuit protection	A ⁷⁾ B ⁸⁾ D ⁹⁾
Protection class	III
Weight	47 g
Polarisation filter	✓
Housing material	Metal, Nickel-plated brass and PC
Optics material	Plastic, PMMA
Enclosure rating	IP67
Items supplied	Reflector P250, fastening nuts (2 x)
Ambient operating temperature	-25 °C ... +55 °C
Ambient temperature, storage	-40 °C ... +70 °C
UL File No.	NRKH2.E300503 & NRKH8.E300503

¹⁾ Limit values when operated in short-circuit protected network: max. 8 A.

²⁾ May not exceed or fall below U_V tolerances.

³⁾ Without load.

⁴⁾ Control wire open: dark switching D.ON.

⁵⁾ Signal transit time with resistive load.

⁶⁾ With light/dark ratio 1:1.

⁷⁾ A = V_S connections reverse-polarity protected.

⁸⁾ B = inputs and output reverse-polarity protected.

⁹⁾ D = outputs overcurrent and short-circuit protected.

Safety-related parameters

MTTF_D	2,006 years
DC_{avg}	0 %

Classifications

eCl@ss 5.0	27270902
eCl@ss 5.1.4	27270902
eCl@ss 6.0	27270902
eCl@ss 6.2	27270902
eCl@ss 7.0	27270902
eCl@ss 8.0	27270902

eCl@ss 8.1	27270902
eCl@ss 9.0	27270902
eCl@ss 10.0	27270902
eCl@ss 11.0	27270902
eCl@ss 12.0	27270902
ETIM 5.0	EC002717
ETIM 6.0	EC002717
ETIM 7.0	EC002717
ETIM 8.0	EC002717
UNSPSC 16.0901	39121528

Connection type

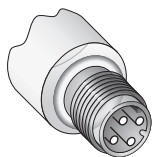

Connection diagram

Cd-087

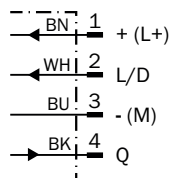

Characteristic curve

VL180-2, 7 m, axial

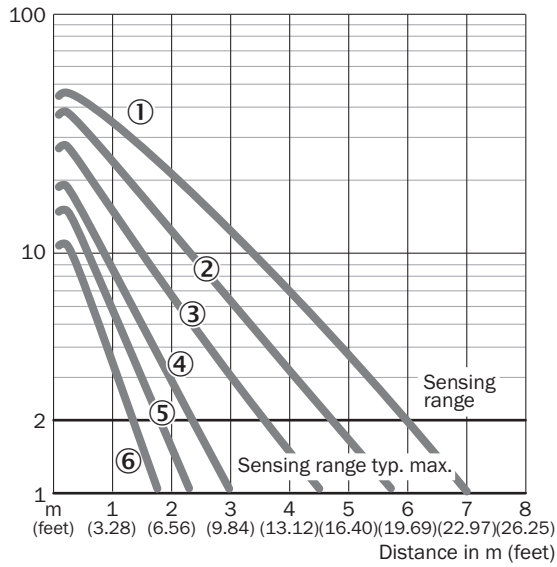

- ① Reflector PL80A
- ② Reflector P250, PL40A, PL50A, C110A
- ③ Reflector PL30A, PL31A
- ④ Reflector PL20A
- ⑤ P45
- ⑥ Reflective tape Diamond Grade

Light spot size

VL180-2

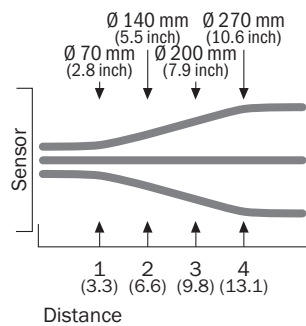

Sensing range diagram

VL180-2, 7 m, axial

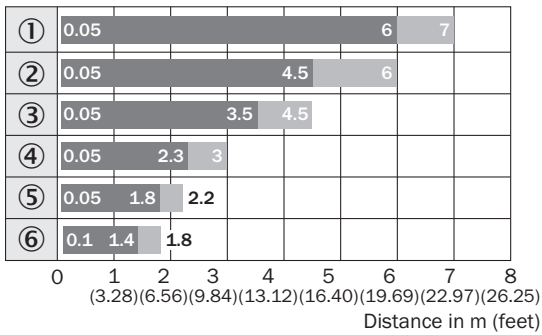

■ Sensing range ■ Sensing range max.

- ① Reflector PL80A
- ② Reflector P250, PL40A, PL50A, C110A
- ③ Reflector PL30A, PL31A
- ④ Reflector PL20A
- ⑤ P45
- ⑥ Reflective tape Diamond Grade

Adjustments

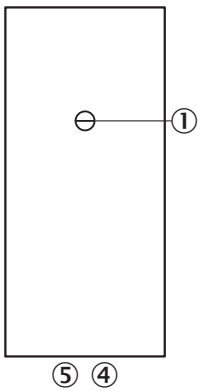

- ③ Sensitivity control 270°
- ④ LED indicator orange: switching output active
- ⑤ LED indicator green

Dimensional drawing (Dimensions in mm (inch))

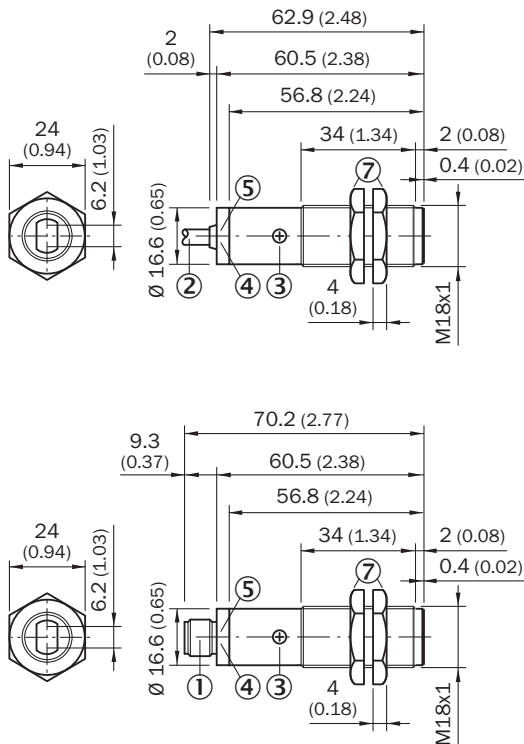

VL180-2, metal, axial



- ① M12 male device connector, 4-pin
- ② Connection cable 2 m
- ③ Sensitivity control 270°
- ④ LED indicator orange: switching output active
- ⑤ LED indicator green: strength indicator
- ⑦ Fastening nuts (2x); width across 24, metal

Recommended accessories

Other models and accessories → www.sick.com/V180-2

	Brief description	Type	Part no.
Plug connectors and cables			
	Head A: female connector, M12, 4-pin, straight, A-coded Head B: Flying leads Cable: Sensor/actuator cable, PVC, unshielded, 5 m	YF2A14-050VB3XLEAX	2096235
	Head A: male connector, M12, 4-pin, straight Cable: unshielded	STE-1204-G	6009932
Reflectors			
	Rectangular, screw connection, 51 mm x 61 mm, PMMA/ABS, Screw-on, 2 hole mounting	P250	5304812

SICK AT A GLANCE

SICK is one of the leading manufacturers of intelligent sensors and sensor solutions for industrial applications. A unique range of products and services creates the perfect basis for controlling processes securely and efficiently, protecting individuals from accidents and preventing damage to the environment.

We have extensive experience in a wide range of industries and understand their processes and requirements. With intelligent sensors, we can deliver exactly what our customers need. In application centers in Europe, Asia and North America, system solutions are tested and optimized in accordance with customer specifications. All this makes us a reliable supplier and development partner.

Comprehensive services complete our offering: SICK LifeTime Services provide support throughout the machine life cycle and ensure safety and productivity.

For us, that is “Sensor Intelligence.”

WORLDWIDE PRESENCE:

Contacts and other locations –www.sick.com