

Part number

CAV 16 LG21



Hood, C-TYPE series, with 1 lever, Pg21 top cable entry, size "77.27", high construction

Product description

Product type	Hood
Series	C-TYPE
Closing type	With 1 lever
Size	Size 77.27
Cable entry	Top cable entry with adapter Pg21
Specification	High construction

Technical data

IP degree of protection IP65 / IP66 / IP69

Further technical details

Weight	339,00 g
Operating temperature range (min, max)	-40°C...+125°C

Material properties

Other materials	Lever: Stainless steel, polyamide (PA) Gasket: NBR
Colour	RAL 7040 grey
RoHs conformity	Compliant with exemption 6(c): copper alloy containing up to 4% lead by weight
China RoHs - EFUP	50
REACH SVHC substances	Yes Lead
SCIP number	15deaf78-e939-4401-a0b0-e2228ca32a03

Approvals / Standards

Certifications	DNV, BV
UL	ECBT2
cUL	ECBT8

General ordering information

EAN13 code 8015747009607

Packaging Information

Packaging length	230,00 mm
Packaging height	160,00 mm
Packaging width	270,00 mm
Packaging weight	3,65 kg
Packaging volume	9,94 dm ³
Packaging description	Carton box
Packaging quantity	10 Pcs
Packaging EAN code	8015747226097
Sub-packaging weight	1,83 kg
Sub-packaging description	Plastic packaging
Sub-packaging quantity	5 Pcs
Sub-packaging EAN barcode	8015747009614

Part number

CAV 16 LG21



Catalogue drawings

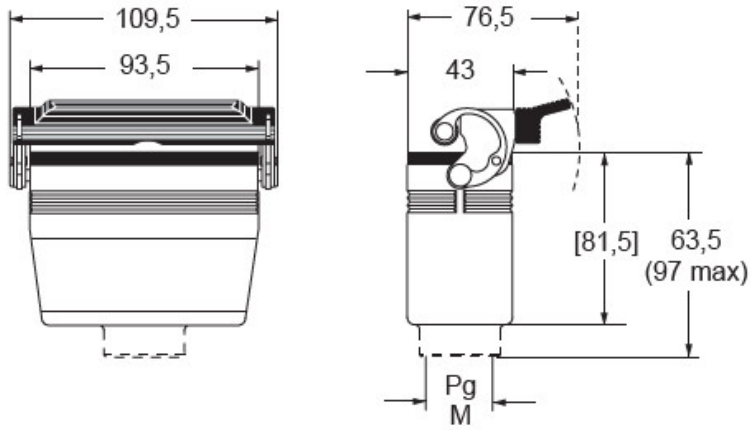

Notes

Dimensions shown in mm are not binding and may be changed without notice.