



Power contactor
BF195

Product designation

Product type designation

Contact characteristics

Number of poles	Nr.	4
Rated insulation voltage U_i IEC/EN	V	1000
Rated impulse withstand voltage U_{imp}	kV	8
Operational frequency	min	Hz 25
	max	Hz 400
IEC Conventional free air thermal current I_{th}	A	275
Operational current I_e	AC-1 ($\leq 40^\circ\text{C}$)	A 275
	AC-1 ($\leq 55^\circ\text{C}$)	A 230
	AC-1 ($\leq 70^\circ\text{C}$)	A 200
	AC-3 ($\leq 440\text{V} \leq 55^\circ\text{C}$)	A 195
	AC-4 (400V)	A 95
Rated operational current AC-3 ($T \leq 55^\circ\text{C}$)	230V	A 195
	400V	A 195
	415V	A 195
	440V	A 195
	500V	A 184
	690V	A 165
	1000V	A 85
Rated operational power AC-1 ($T \leq 40^\circ\text{C}$)	230V	kW 104
	400V	kW 181
	500V	kW 199
	690V	kW 312
IEC max current I_e in DC1 with $L/R \leq 1\text{ms}$ with 1 poles in series	$\leq 24\text{V}$	A 275
	48V	A 275
	75V	A 275
	110V	A 120
	220V	A -
IEC max current I_e in DC1 with $L/R \leq 1\text{ms}$ with 2 poles in series	$\leq 24\text{V}$	A 275
	48V	A 275
	75V	A 275
	110V	A 170
	220V	A 150
IEC max current I_e in DC1 with $L/R \leq 1\text{ms}$ with 3 poles in series	$\leq 24\text{V}$	A 275
	48V	A 275
	75V	A 275

	110V	A	170
	220V	A	150
	330V	A	150
<hr/>			
IEC max current I _e in DC1 with L/R ≤ 1ms with 4 poles in series			
	≤24V	A	275
	48V	A	275
	75V	A	275
	110V	A	275
	220V	A	350
<hr/>			
IEC max current I _e in DC3-DC5 with L/R ≤ 15ms with 1 poles in series			
	≤24V	A	275
	48V	A	275
	75V	A	180
	110V	A	90
	220V	A	–
<hr/>			
IEC max current I _e in DC3-DC5 with L/R ≤ 15ms with 2 poles in series			
	≤24V	A	275
	48V	A	275
	75V	A	180
	110V	A	140
	220V	A	100
<hr/>			
IEC max current I _e in DC3-DC5 with L/R ≤ 15ms with 3 poles in series			
	≤24V	A	275
	48V	A	275
	75V	A	180
	110V	A	160
	220V	A	140
	330V	A	100
<hr/>			
IEC max current I _e in DC3-DC5 with L/R ≤ 15ms with 4 poles in series			
	≤24V	A	275
	48V	A	275
	75V	A	180
	110V	A	160
	220V	A	160
	330V	A	160
	460V	A	100
<hr/>			
Short-time allowable current for 10s (IEC/EN60947-1)		A	1560
<hr/>			
Protection fuse			
	gG (IEC)	A	315
	aM (IEC)	A	250
<hr/>			
Making capacity (RMS value)		A	1658
<hr/>			
Breaking capacity at voltage			
	440V	A	1658
	500V	A	1326
	690V	A	1377
<hr/>			
Resistance per pole (average value)		mΩ	0.18
<hr/>			
Power dissipation per pole (average value)			
	I _{th}	W	13
	AC-3	W	6.7
<hr/>			
Tightening torque for terminals			
	min	Nm	18
	max	Nm	18
	min	I _{bin}	159
	max	I _{bin}	159

Tightening torque for coil terminal

min	Nm	0.8
max	Nm	1

Power terminal protection according to IEC/EN 60529

IP00

Mechanical features

Operating position

normal	Vertical plan
allowable	±30°

Fixing

Screw

Weight

g 4000

Operations

Mechanical life

cycles 10000000

Electrical life

cycles 1000000

Safety related data

Performance level B10d according to EN/ISO 13489-1

rated load	cycles	1000000
------------	--------	---------

EMC compatibility

yes

AC coil operating

Rated AC voltage at 50/60Hz, 60Hz

min	V	250
max	V	500

AC operating voltage

of 50/60Hz coil powered at 50Hz
pick-up

min	%Us	80 Us min
max	%Us	110 Us max

drop-out

max	%Us	≤70 Us min
-----	-----	------------

of 50/60Hz coil powered at 60Hz
pick-up

min	%Us	80 Us min
max	%Us	110 Us max

drop-out

max	%Us	≤70 Us min
-----	-----	------------

AC average coil consumption at 20°C

of 50/60Hz coil powered at 50Hz

in-rush	VA	160...230
holding	VA	1.5...3.0

of 50/60Hz coil powered at 60Hz

in-rush	VA	160...230
holding	VA	1.5...3.0

of 60Hz coil powered at 60Hz

in-rush	VA	160...230
holding	VA	1.5...3.0

Dissipation at holding ≤20°C 50Hz

W 1.5...3.0

DC coil operating

DC rated control voltage

min	V	250
max	V	500

DC operating voltage

pick-up

min	%Us	85 Us min
max	%Us	110 Us max

drop-out			
		max	%Us ≤70 Us min
Average coil consumption ≤20°C			
	in-rush	W	160...230
	holding	W	1.5...3.0
Max cycles frequency			
Mechanical operation			cycles/h 1000
Operating times			
Average time for Us control			
in AC			
Closing NO			
	min	ms	50
	max	ms	100
Opening NO			
	min	ms	35
	max	ms	75
UL technical data			
Yielded mechanical performance			
for three-phase AC motor			
	200/208V	HP	60
	220/230V	HP	75
	460/480V	HP	150
	575/600V	HP	150
General USE			
Contactor			
	AC current	A	275
Short-circuit protection fuse, 600V			
High fault			
	Short circuit current	kA	100
	Fuse rating	A	400
	Fuse class		J
Standard fault			
	Short circuit current	kA	10
	Fuse rating	A	400
	Fuse class		RK5
Ambient conditions			
Temperature			
Operating temperature			
	min	°C	-40
	max	°C	70
Storage temperature			
	min	°C	-50
	max	°C	80
Max altitude			m 3000
Resistance & Protection			
Pollution degree			3
Dimensions			

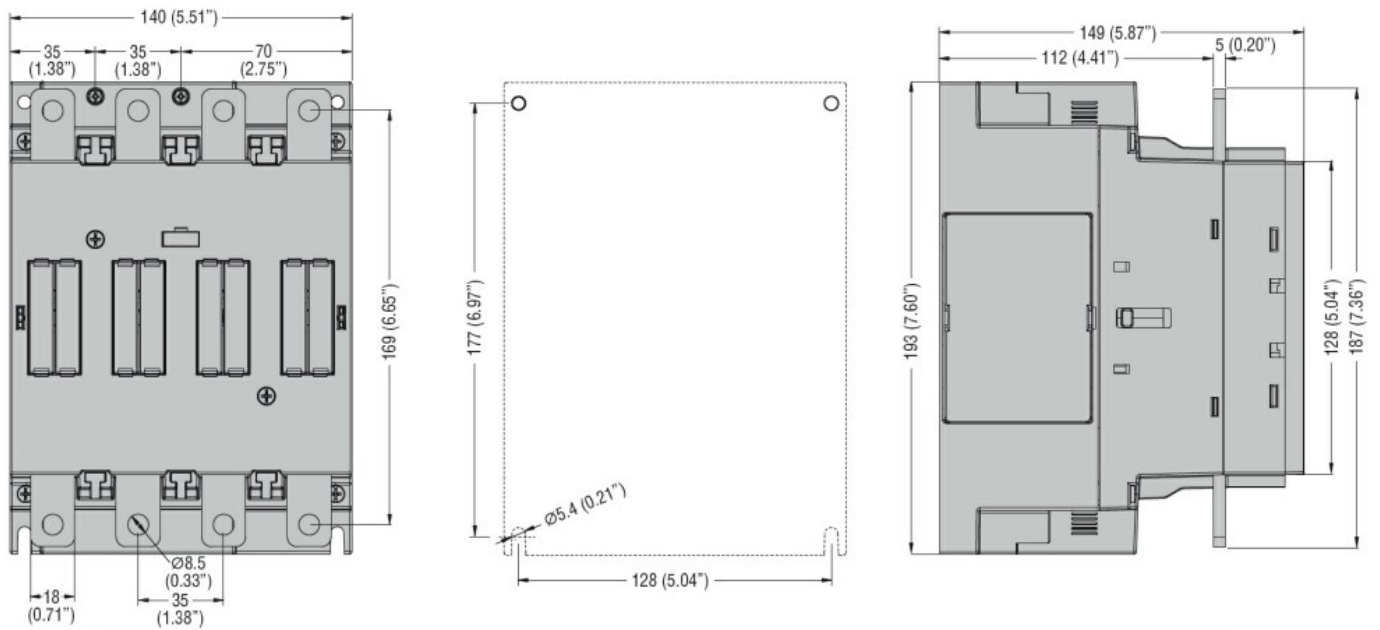

Wiring diagrams

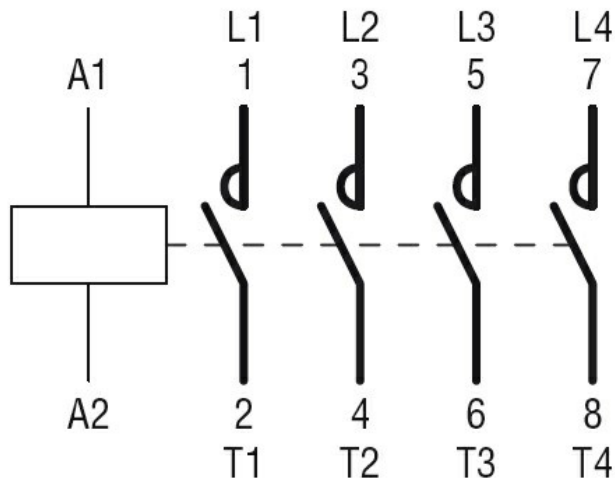

Certifications and compliance

Compliance

CSA C22.2 n° 60947-1

CSA C22.2 n° 60947-4-1

IEC/EN/BS 60947-1

IEC/EN/BS 60947-4-1

UL 60947-1

UL 60947-4-1

Certificates

cULus

ETIM classification

ETIM 8.0

EC000066 -
Power contactor,
AC switching