

NOTICE DE SECURITE

- Lisez attentivement les instructions avant utilisation
- Conservez cette notice tant que vous utilisez l'appareil.
- Le montage et l'entretien sont réservés à des personnes qualifiées pouvant intervenir sur des produits devant être reliés manuellement à du courant 230V
- Avant toute action de montage, coupez l'alimentation électrique
- Reliez en premier le câble de la mise à la terre
- Luminaire conçu pour installation directe sur des surfaces normalement inflammables
- Ce produit répond à toutes les exigences essentielles de chacune des directives qui lui sont applicables.
- En fin de vie, ce produit doit faire l'objet d'une collecte séparée et ne doit pas être mélangé aux autres déchets ménagers pour le respect de la santé et de la sécurité des personnes et pour la conservation des ressources naturelles.

INSTRUCCIONES DE SEGURIDAD

- Lea las instrucciones cuidadosamente antes de usar
- Guarde estas instrucciones mientras usa el dispositivo.
- La instalación y el mantenimiento están reservados para personas calificadas que pueden trabajar en productos que deben conectarse manualmente a una corriente de 230V
- Antes de cualquier acción de montaje, corte la fuente de alimentación.
- Conecte primero el cable de tierra
- Luminaria diseñada para instalación directa en superficies normalmente inflamables.
- Este producto cumple con todos los requisitos esenciales de cada una de las directivas que le son aplicables.
- Al final de su vida útil, este producto debe recolectarse por separado y no debe mezclarse con otros desechos domésticos para el respeto de la salud y la seguridad humana y para la conservación de los recursos naturales.

SICHERHEITSHINWEISE

- Lesen Sie die Anweisungen vor dem Gebrauch sorgfältig durch
- Bewahren Sie diese Anweisungen auf, während Sie das Gerät verwenden.
- Installation und Wartung sind qualifizierten Personen vorbehalten, die an Produkten arbeiten können, die manuell an 230V angeschlossen werden müssen
- Unterbrechen Sie vor jeder Montage die Stromversorgung
- Schließen Sie zuerst das Erdungskabel an
- Leuchte zur direkten Installation auf normal brennbaren Oberflächen
- Dieses Produkt erfüllt alle grundlegenden Anforderungen der jeweils geltenden Richtlinien.
- Dieses Produkt muss am Ende seiner Lebensdauer getrennt gesammelt und nicht zum Schutz der menschlichen Gesundheit und Sicherheit sowie zur Erhaltung der natürlichen Ressourcen mit anderen Haushaltsabfällen gemischt werden.

SAFETY NOTE

- Read the instructions carefully before use
- Keep these instructions while you use the device.
- Installation and maintenance are reserved for qualified people who can work on products that must be manually connected to 230V current
- Before any assembly action, cut off the power supply
- Connect the earth cable first
- Luminaire designed for direct installation on normally flammable surfaces
- This product meets all the essential requirements of each of the directives applicable to it.
- At the end of its life, this product must be collected separately and must not be mixed with other household waste for the respect of human health and safety and for the conservation of natural resources.

AVVISO DI SICUREZZA

- Leggere attentamente le istruzioni prima dell'uso
- Conservare queste istruzioni mentre si utilizza il dispositivo.
- L'installazione e la manutenzione sono riservate a personale qualificato che può lavorare su prodotti che devono essere collegati manualmente alla corrente a 230V.
- Prima di qualsiasi azione di assemblaggio, interrompere l'alimentazione elettrica
- Collegare prima il cavo di terra
- Apparecchio progettato per l'installazione diretta su superfici normalmente infiammabili
- Questo prodotto soddisfa tutti i requisiti essenziali di ciascuna delle direttive ad esso applicabili.
- Alla fine della sua vita, questo prodotto deve essere raccolto separatamente e non deve essere miscelato con altri rifiuti domestici per il rispetto della salute e della sicurezza umana e per la conservazione delle risorse naturali.

ref. 8253*
KIT DE SUSPENSION

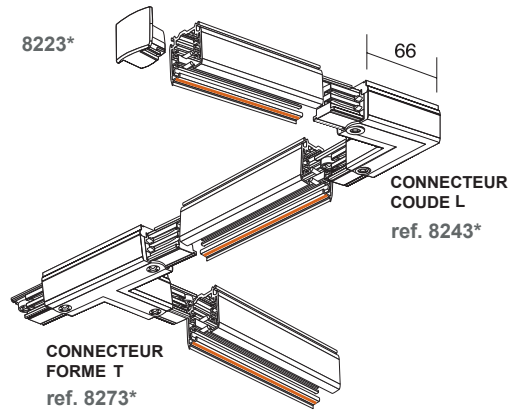
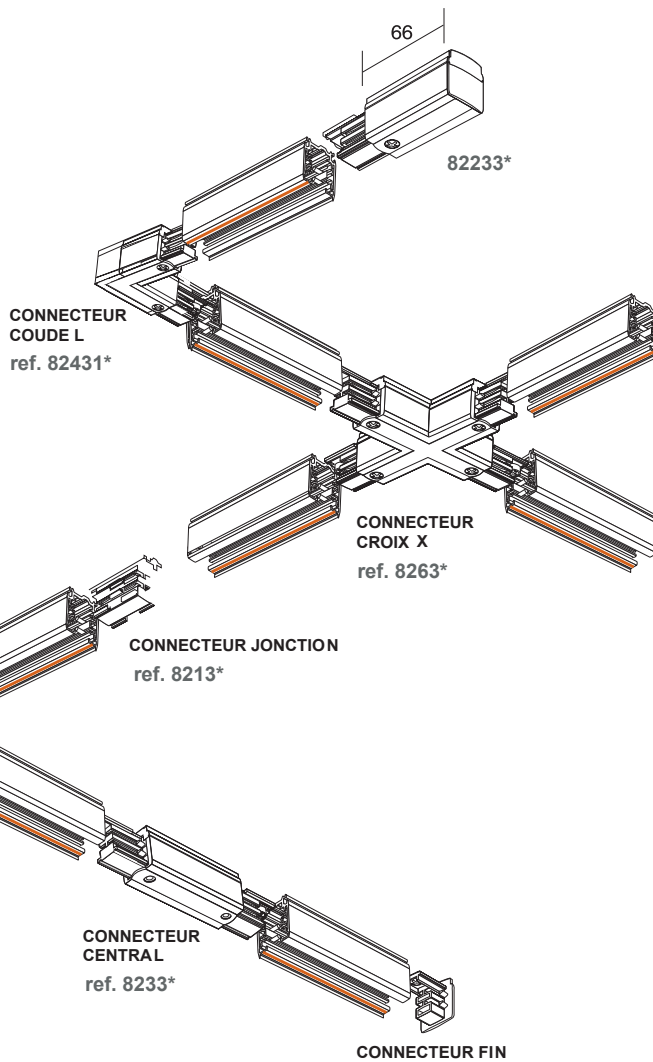
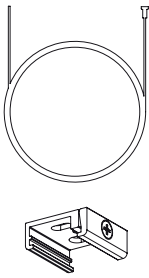

XTS Rectangulaire

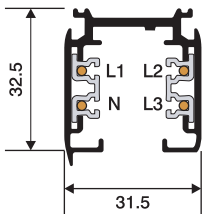

* finition noire

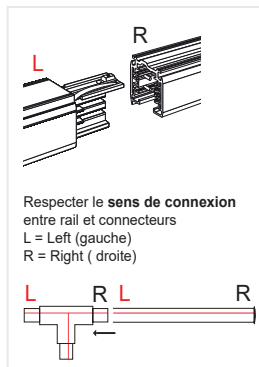

ref. 82431* ref. 8273* ref. 82431*

ref. 82431* ref. 8273GE* ref. 82431*
ref. 8243* ref. 8273DI* ref. 8243*

ref. 8243* ref. 8273GI* ref. 8243*

Vue du sol

Circuit Intérieur

ref. 8273GI* ref. 8273GI* ref. 8273DI*

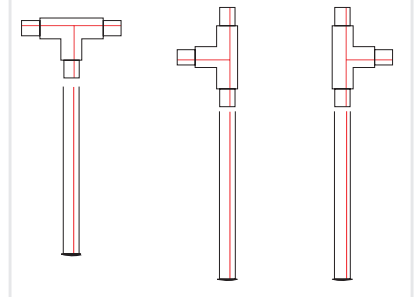

Circuit Extérieur

ref. 8273* ref. 8273GE* ref. 8273*

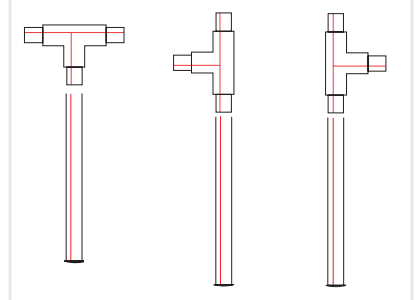

La ligne rouge indique les polarités

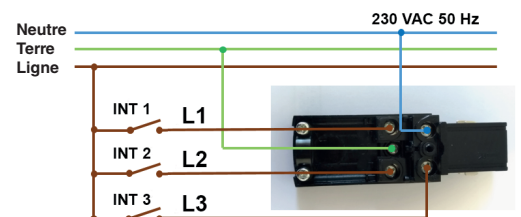

Tous les schéma sont des vues de dessous

CONNECTEUR ALIM ET FIN

Droit

Gauche

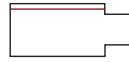

CONNECTEUR COUDE L

Droit - Circuit intérieur

Gauche - Circuit intérieur



CONNECTEUR FORME T

Droit - Circuit intérieur

Gauche - Circuit intérieur

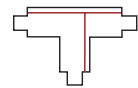
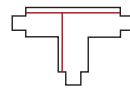

Droit - Circuit intérieur

Gauche - Circuit intérieur

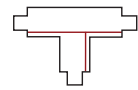
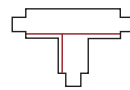

CONNECTEUR CROIX X

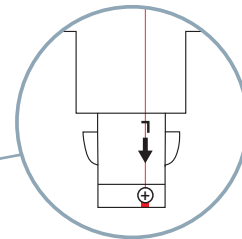
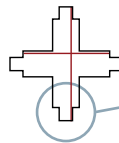
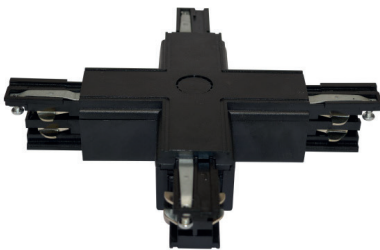

Connecteur rail flexible



Connecteur rail jonction



Connecteur central



Connecteur rail 3 allumages



MONTAGE SUSPENSION

