

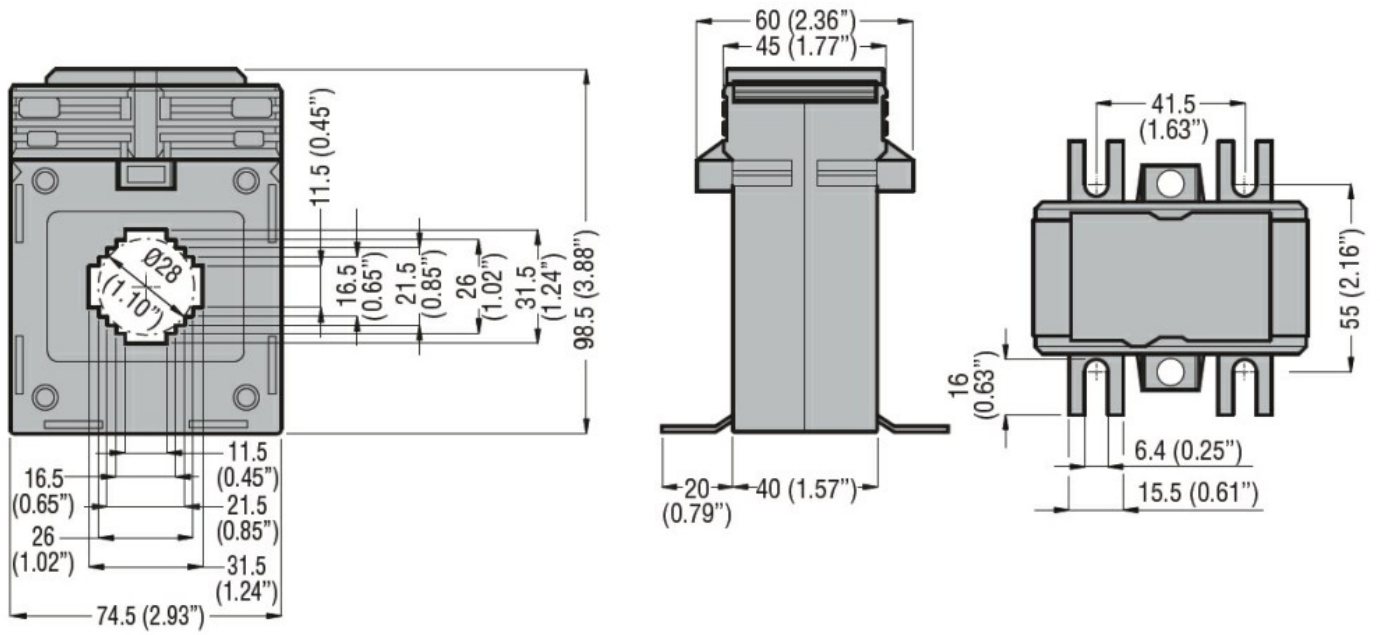

Product designation				Current transformers
Product type designation				DM1TP0060
Type of CT				Solid-core
Current inputs				
Primary current I _{pn} (/5)			A	60
Operational frequency	min	Hz	50	
	max	Hz	60	
Secondary output current			A	5
Overload withstand I _{pn}			%	120
Burden	cl. 0.5s	VA	1.5	
	cl. 0.5	VA	1.5	
Insulations				
Rated insulation voltage U _i IEC/EN			V	720
IEC rated short-time thermal current I _{th}			I _{th} for s	40...60
IEC rated dynamic current I _{dyn}			I _{th} for s	2.5
Insulation dry type				Class E
Mechanical features				
Terminals type				Screw
Fixing				DIN rail or by Screw
Weight			g	560
Ambient conditions				
Temperature	Operating temperature	min	°C	-25
		max	°C	+50
	Storage temperature	min	°C	-40
		max	°C	+80
Relative humidity			%	90
Protection degree				IP30
Dimensions				



Certifications and compliance

Certifications

IEC/EN/BS 61869-1

IEC/EN/BS 61869-2

Compliance

EAC

ETIM classification

EC000066 - Power contactor, AC switching

□