



Product designation

Auxiliary
contactor

Product type designation

BG12

Contact characteristics

Number of poles	Nr.	3
Rated insulation voltage U_i IEC/EN	V	690
Rated impulse withstand voltage U_{imp}	kV	6
Operational frequency	min	Hz 25
	max	Hz 400
IEC Conventional free air thermal current I_{th}	A	20
Operational current I_e	AC-1 ($\leq 40^\circ\text{C}$)	A 20
	AC-1 ($\leq 55^\circ\text{C}$)	A 18
	AC-1 ($\leq 70^\circ\text{C}$)	A 15
	AC-3 ($\leq 440\text{V} \leq 55^\circ\text{C}$)	A 12
	AC-4 (400V)	A 4.8
Rated operational power AC-3 ($T \leq 55^\circ\text{C}$)	230V	kW 3.2
	400V	kW 5.7
	415V	kW 6.2
	440V	kW 5.5
	500V	kW 5
	690V	kW 5
Rated operational power AC-1 ($T \leq 40^\circ\text{C}$)	230V	kW 8
	400V	kW 14
	500V	kW 16
	690V	kW 22
IEC max current I_e in DC1 with $L/R \leq 1\text{ms}$ with 1 poles in series	$\leq 24\text{V}$	A 12
	48V	A 10
	75V	A 4
	110V	A 3
	220V	A –
IEC max current I_e in DC1 with $L/R \leq 1\text{ms}$ with 2 poles in series	$\leq 24\text{V}$	A 15
	48V	A 14
	75V	A 9
	110V	A 8
	220V	A –
IEC max current I_e in DC1 with $L/R \leq 1\text{ms}$ with 3 poles in series	$\leq 24\text{V}$	A 16
	48V	A 16
	75V	A 10
	110V	A 10

	220V	A	2
IEC max current Ie in DC1 with L/R ≤ 1ms with 4 poles in series			
	≤24V	A	–
	48V	A	–
	75V	A	–
	110V	A	–
	220V	A	–
IEC max current Ie in DC3-DC5 with L/R ≤ 15ms with 1 poles in series			
	≤24V	A	7
	48V	A	6
	75V	A	2
	110V	A	1
	220V	A	–
IEC max current Ie in DC3-DC5 with L/R ≤ 15ms with 2 poles in series			
	≤24V	A	8
	48V	A	8
	75V	A	5
	110V	A	4
	220V	A	–
IEC max current Ie in DC3-DC5 with L/R ≤ 15ms with 3 poles in series			
	≤24V	A	10
	48V	A	10
	75V	A	6
	110V	A	5
	220V	A	0,8
IEC max current Ie in DC3-DC5 with L/R ≤ 15ms with 4 poles in series			
	≤24V	A	–
	48V	A	–
	75V	A	–
	110V	A	–
	220V	A	–
Short-time allowable current for 10s (IEC/EN60947-1)		A	96
Protection fuse			
	gG (IEC)	A	20
	aM (IEC)	A	16
Making capacity (RMS value)		A	120
Breaking capacity at voltage			
	440V	A	96
	500V	A	72
	690V	A	72
Resistance per pole (average value)		mΩ	10
Power dissipation per pole (average value)			
	Ith	W	4
	AC-3	W	1.4
Tightening torque for terminals			
	min	Nm	0.8
	max	Nm	1
	min	Ibin	9
	max	Ibin	9
Tightening torque for coil terminal			
	min	Nm	0.8
	max	Nm	1
	min	Ibin	9

		max	I _{bin}	9
Max number of wires simultaneously connectable			Nr.	2
Conductor section	AWG/Kcmil	max		12
Flexible w/o lug conductor section		min	mm ²	0.8
		max	mm ²	2.5
Flexible c/w lug conductor section		min	mm ²	1.5
		max	mm ²	2.5
Flexible with insulated spade lug conductor section		min	mm ²	1.5
		max	mm ²	2.5
Power terminal protection according to IEC/EN 60529				IP20
Mechanical features				
Operating position		normal allowable		Vertical plan ±30°
Fixing				Screw / DIN rail 35mm
Weight			g	200
Conductor section	AWG/kcmil conductor section	max		12
Auxiliary contact characteristics				
Thermal current I _{th}			A	10
IEC/EN 60947-5-1 designation				A600
Operating current AC15		230V	A	3
		400V	A	1.9
		500V	A	1.4
Operating current DC12		110V	A	2.9
Operating current DC13		24V	A	2.9
		48V	A	1.4
		60V	A	1.2
		110V	A	0.6
		125V	A	0.55
		220V	A	0.3
		600V	A	0.1
Operations				
Mechanical life			cycles	20000000
Electrical life			cycles	500000
Safety related data				
Performance level B10d according to EN/ISO 13489-1		rated load	cycles	500000
		mechanical load	cycles	20000000
Mirror contacts according to IEC/EN 60947-4-1				YES
EMC compatibility				YES
AC coil operating				
Rated AC voltage at 60Hz			V	24

AC operating voltage

of 60Hz coil powered at 60Hz				
pick-up	min	%Us	75	
	max	%Us	115	
drop-out	min	%Us	20	
	max	%Us	55	

AC average coil consumption at 20°C

of 50/60Hz coil powered at 50Hz				
	in-rush	VA	30	
	holding	VA	4	
of 50/60Hz coil powered at 60Hz				
	in-rush	VA	25	
	holding	VA	3	
of 60Hz coil powered at 60Hz				
	in-rush	VA	30	
	holding	VA	4	

Dissipation at holding ≤20°C 50Hz

W 0.9

Max cycles frequency

Mechanical operation

cycles/h 3600

Operating times

Average time for Us control

in AC

Closing NO	min	ms	12
	max	ms	21
Opening NO	min	ms	9
	max	ms	18
Closing NC	min	ms	17
	max	ms	26
Opening NC	min	ms	7
	max	ms	17

in DC

Closing NO	min	ms	18
	max	ms	25
Opening NO	min	ms	2
	max	ms	3
Closing NC	min	ms	3
	max	ms	5
Opening NC	min	ms	11
	max	ms	17

UL technical data

Full-load current (FLA) for three-phase AC motor

at 480V	A	11
at 600V	A	11

Yielded mechanical performance

for single-phase AC motor

110/120V	HP	0.5
230V	HP	1.5

for three-phase AC motor

200/208V	HP	3
220/230V	HP	3
460/480V	HP	7.5
575/600V	HP	10

General USE

Contactor

AC current	A	20
------------	---	----

Short-circuit protection fuse, 600V

High fault

Short circuit current	kA	100
Fuse rating	A	30
Fuse class		J

Standard fault

Short circuit current	kA	5
Fuse rating	A	30
Fuse class		RK5

Contact rating of auxiliary contacts according to UL

A600 - Q600

Ambient conditions

Temperature

Operating temperature

min	°C	-50
max	°C	+70

Storage temperature

min	°C	-60
max	°C	+80

Max altitude

m 3000

Resistance & Protection

Pollution degree

3

Dimensions

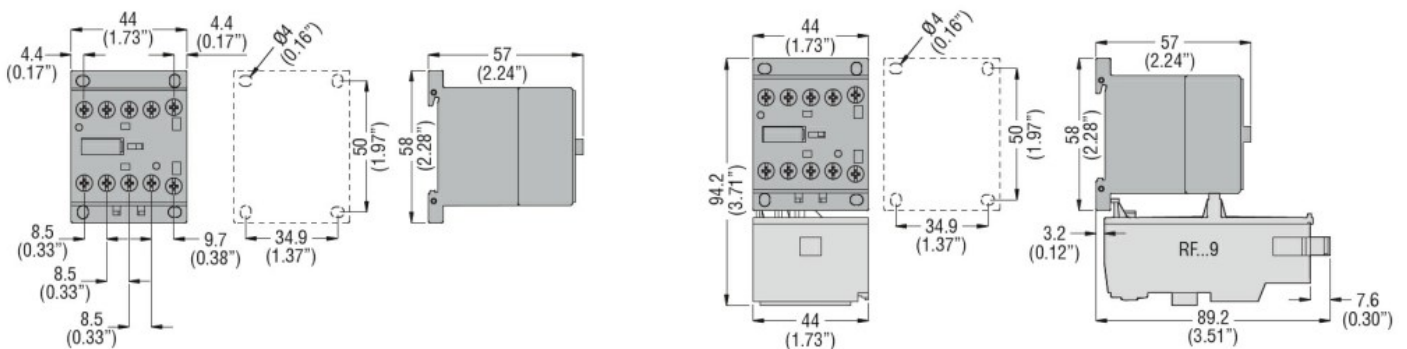

Wiring diagrams



Certifications and compliance

Compliance

CSA C22.2 n° 60947-1

CSA C22.2 n° 60947-4-1

IEC/EN 60947-1

IEC/EN 60947-4-1

UL 60947-1

UL 60947-4-1

Certificates

CCC

cULus

EAC

ETIM classification

ETIM 8.0

EC000066 -
Power contactor,
AC switching