



Product designation				Power contactor
Product type designation				BF94
<b>Contact characteristics</b>				
Number of poles	Nr.	3		
Rated insulation voltage U <sub>i</sub> IEC/EN	V	1000		
Rated impulse withstand voltage U <sub>imp</sub>	kV	8		
Operational frequency	min	Hz	25	
	max	Hz	400	
IEC Conventional free air thermal current I <sub>th</sub>	A	115		
Operational current I <sub>e</sub>	AC-1 (≤40°C)	A	115	
	AC-1 (≤55°C)	A	95	
	AC-1 (≤70°C)	A	80	
	AC-3 (≤440V ≤55°C)	A	95	
	AC-4 (400V)	A	45	
Rated operational power AC-3 (T≤55°C)	230V	kW	30	
	400V	kW	55	
	415V	kW	55	
	440V	kW	55	
	500V	kW	55	
	690V	kW	55	
	1000V	kW	37	
Rated operational current AC-3 (T≤55°C)	230V	A	94	
	400V	A	94	
	415V	A	94	
	440V	A	94	
	500V	A	78	
	690V	A	57	
	1000V	A	28	
IEC max current I <sub>e</sub> in DC1 with L/R ≤ 1ms with 1 poles in series	≤24V	A	77	
	48V	A	66	
	75V	A	66	
	110V	A	8	
	220V	A	–	
	IEC max current I <sub>e</sub> in DC1 with L/R ≤ 1ms with 2 poles in series	≤24V	A	110
48V		A	110	
75V		A	110	
110V		A	90	
220V		A	9	
IEC max current I <sub>e</sub> in DC1 with L/R ≤ 1ms with 3 poles in series				

	≤24V	A	110
	48V	A	110
	75V	A	110
	110V	A	93
	220V	A	95
<hr/>			
IEC max current I <sub>e</sub> in DC1 with L/R ≤ 1ms with 4 poles in series	≤24V	A	115
	48V	A	115
	75V	A	115
	110V	A	110
	220V	A	115
<hr/>			
IEC max current I <sub>e</sub> in DC3-DC5 with L/R ≤ 15ms with 1 poles in series	≤24V	A	45
	48V	A	33
	75V	A	33
	110V	A	3
	220V	A	–
<hr/>			
IEC max current I <sub>e</sub> in DC3-DC5 with L/R ≤ 15ms with 2 poles in series	≤24V	A	65
	48V	A	55
	75V	A	55
	110V	A	43
	220V	A	5
<hr/>			
IEC max current I <sub>e</sub> in DC3-DC5 with L/R ≤ 15ms with 3 poles in series	≤24V	A	86
	48V	A	75
	75V	A	75
	110V	A	64
	220V	A	64
<hr/>			
IEC max current I <sub>e</sub> in DC3-DC5 with L/R ≤ 15ms with 4 poles in series	≤24V	A	96
	48V	A	95
	75V	A	95
	110V	A	80
	220V	A	80
<hr/>			
Short-time allowable current for 10s (IEC/EN60947-1)		A	640
<hr/>			
Protection fuse	gG (IEC)	A	125
	aM (IEC)	A	100
<hr/>			
Making capacity (RMS value)		A	950
<hr/>			
Breaking capacity at voltage	440V	A	640
	500V	A	625
	690V	A	456
<hr/>			
Resistance per pole (average value)		mΩ	0.6
<hr/>			
Power dissipation per pole (average value)	I <sub>th</sub>	W	7.9
	AC-3	W	5.4
<hr/>			
Tightening torque for terminals	min	Nm	4
	max	Nm	5
	min	I <sub>bin</sub>	3
	max	I <sub>bin</sub>	3.7

Tightening torque for coil terminal

min	Nm	0.8
max	Nm	1
min	Ibin	0.59
max	Ibin	0.74

Max number of wires simultaneously connectable

Nr.	2
-----	---

Conductor section

Flexible w/o lug conductor section

min	mm <sup>2</sup>	1.5
max	mm <sup>2</sup>	35

Power terminal protection according to IEC/EN 60529

IP20

**Mechanical features**

Operating position

normal allowable	Vertical plan ±30°
------------------	--------------------

Fixing

Screw / DIN rail 35mm

Weight

g 1

**Operations**

Mechanical life

cycles 15000000

Electrical life

cycles 1100000

**Safety related data**

Mirror contacts according to IEC/EN 609474-4-1

YES

EMC compatibility

yes

**AC coil operating**

Rated AC voltage at 60Hz

V 230

AC operating voltage

of 50/60Hz coil powered at 50Hz drop-out

min	%Us	20
max	%Us	55

of 50/60Hz coil powered at 60Hz pick-up

min	%Us	85
max	%Us	110

drop-out

min	%Us	20
max	%Us	55

of 60Hz coil powered at 60Hz pick-up

min	%Us	80
max	%Us	110

drop-out

min	%Us	20
max	%Us	55

AC average coil consumption at 20°C

of 60Hz coil powered at 60Hz

in-rush	VA	210
holding	VA	15

Dissipation at holding ≤20°C 50Hz

W 5

**Max cycles frequency**

Mechanical operation

cycles/h 3600

**Operating times**

Average time for Us control

in AC	Closing NO	min	ms	12
		max	ms	28
	Opening NO	min	ms	8
		max	ms	22
in DC	Closing NO	min	ms	40
		max	ms	85
	Opening NO	min	ms	20
		max	ms	55

**UL technical data**

Full-load current (FLA) for three-phase AC motor

at 480V	A	77
at 600V	A	77

Yielded mechanical performance

for three-phase AC motor

200/208V	HP	25
220/230V	HP	30
460/480V	HP	60
575/600V	HP	75

General USE

Contactor

AC current	A	115
------------	---	-----

Short-circuit protection fuse, 600V

High fault

Short circuit current	kA	100
Fuse rating	A	200
Fuse class		J

Standard fault

Short circuit current	kA	10
Fuse rating	A	200
Fuse class		RK5

**Ambient conditions**

Temperature

Operating temperature

min	°C	-50
max	°C	70

Storage temperature

min	°C	-60
max	°C	80

Max altitude

m	3000
---	------

**Dimensions**

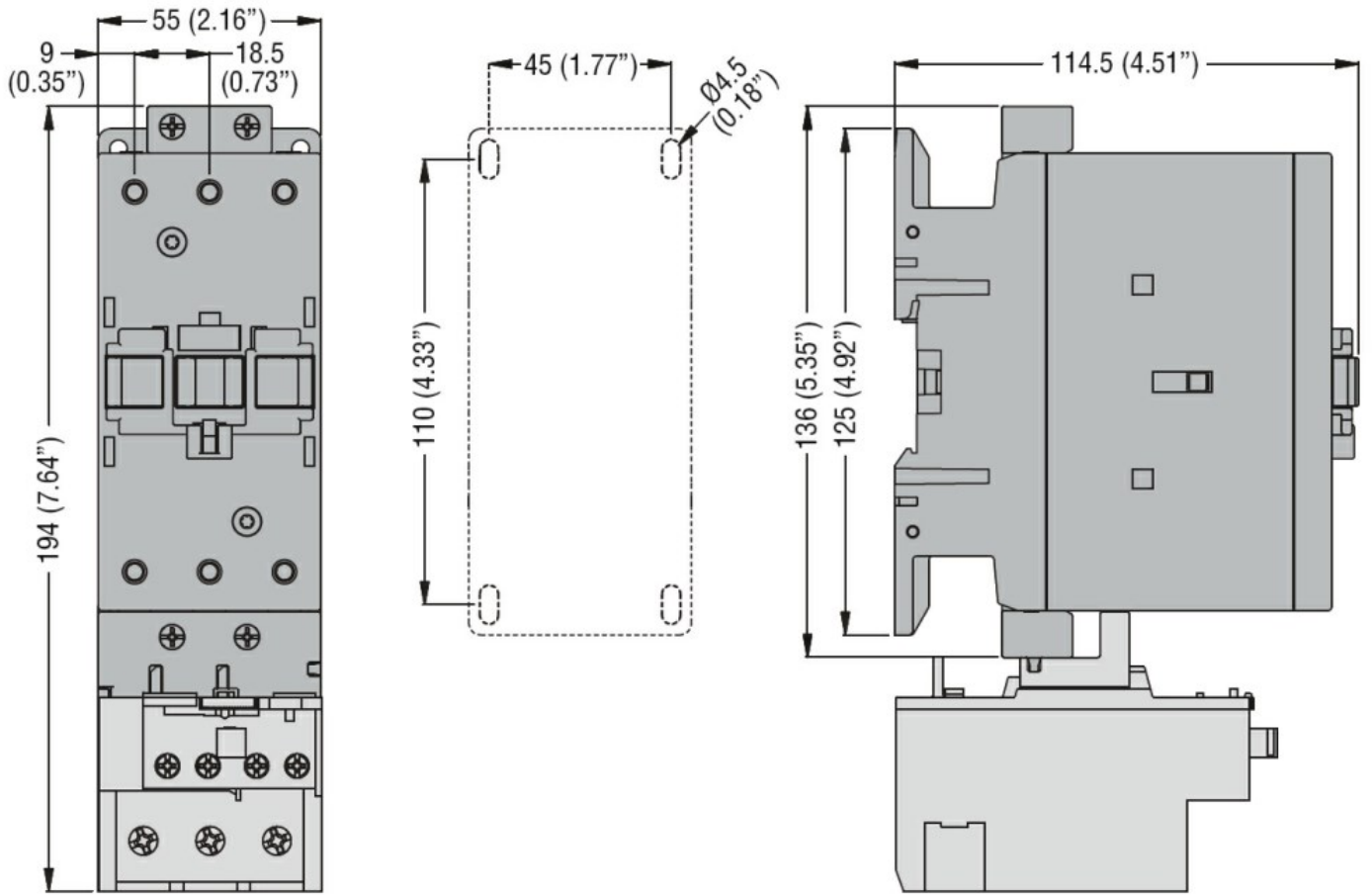

### Wiring diagrams

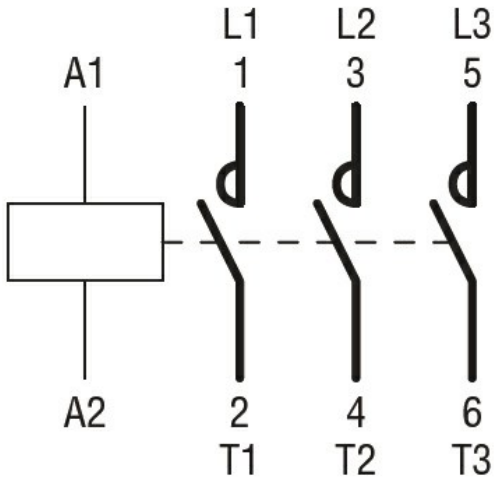

### Certifications and compliance

#### Compliance

CSA C22.2 n° 60947-1  
 CSA C22.2 n° 60947-4-1  
 IEC/EN/BS 60947-1  
 IEC/EN/BS 60947-4-1  
 UL 60947-1  
 UL 60947-4-1

#### Certificates

CCC

---

cULus

---

EAC

ETIM classification

ETIM 8.0

EC000066 -  
Power contactor,  
AC switching