



# MLG20A-1480B10501

MLG-2

MEASURING AUTOMATION LIGHT GRIDS

**SICK**  
Sensor Intelligence.



Illustration may differ

### Ordering information

Type	Part no.
MLG20A-1480B10501	1220295

Other models and accessories → [www.sick.com/MLG-2](http://www.sick.com/MLG-2)



### Detailed technical data

#### Features

<b>Device version</b>	Pro - Advanced functionality
<b>Sensor principle</b>	Sender/receiver
<b>Minimum detectable object (MDO)</b>	20 mm, 24 mm <sup>1) 2) 3)</sup>
<b>Beam separation</b>	20 mm
<b>Type of synchronization</b>	Cable
<b>Number of beams</b>	75
<b>Detection height</b>	1,480 mm
<b>Software features (default)</b>	<ul style="list-style-type: none"> <li>Q<sub>A1</sub> Number of broken beams/NBB</li> <li>Q<sub>A2</sub> Height measurement (last beam)/LBB</li> <li>Q<sub>1</sub> Presence detection</li> <li>Q2 / IN Teach input</li> <li>Teach Standard mode</li> </ul>
<b>Operating mode</b>	<ul style="list-style-type: none"> <li>Standard ✓</li> <li>Transparent ✓</li> <li>Dust- and sunlight-resistant ✓</li> </ul>
<b>Function</b>	<ul style="list-style-type: none"> <li>Cross beam ✓</li> </ul>

<sup>1)</sup> MDO min. detectable object at high measurement accuracy.

<sup>2)</sup> MDO min. detectable object for standard measurement accuracy.

<sup>3)</sup> Depending on beam separation without cross beam setting.

Beam blanking	✓
High-speed scan	✓
High measurement accuracy	✓
<b>Applications</b>	
Switching output	Object recognition/object width Object recognition Height classification Hole detection/hole size Outside dimension/inside dimension Object position Hole position Zone definition
Data interface	Object detection Hole detection Object height measurement Measurement of external dimension Measurement of inside dimension Measurement of object position Measurement of hole position
<b>Included with delivery</b>	1 × sender 1 × receiver 4/6 × QuickFix brackets (6 × QuickFix brackets for monitoring heights above 2 m) 1 × Quick Start Guide

1) MDO min. detectable object at high measurement accuracy.

2) MDO min. detectable object for standard measurement accuracy.

3) Depending on beam separation without cross beam setting.

## Mechanics/electronics

<b>Light source</b>	LED, Infrared light
<b>Wave length</b>	850 nm
<b>Supply voltage <math>V_s</math></b>	DC 19.2 V ... 28.8 V <sup>1)</sup>
<b>Power consumption sender</b>	58.75 mA <sup>2)</sup>
<b>Power consumption receiver</b>	135 mA <sup>2)</sup>
<b>Ripple</b>	< 5 V <sub>pp</sub>
<b>Output current <math>I_{max}</math></b>	100 mA
<b>Output load, capacitive</b>	100 nF
<b>Output load, Inductive</b>	1 H
<b>Initialization time</b>	< 1 s
<b>Switching output</b>	Push-pull: PNP/NPN
<b>Connection type</b>	Male connector M12, 5-pin, 0.22 m Male connector M12, 8-pin, 0.27 m M12 female connector, 4-pin, D-coded, 0.19 m
<b>Housing material</b>	Aluminum
<b>Indication</b>	LED
<b>Enclosure rating</b>	IP65, IP67 <sup>3)</sup>
<b>Circuit protection</b>	U <sub>V</sub> connections, reverse polarity protected Output Q short-circuit protected

1) Without load.

2) , Without load with 24 V.

3) Operating in outdoor condition only with a external protection housing.

	Interference pulse suppression
<b>Protection class</b>	III
<b>Weight</b>	3.249 kg
<b>Front screen</b>	PMMA
<b>Option</b>	None
<b>UL File No.</b>	NRKH.E181493

<sup>1)</sup> Without load.

<sup>2)</sup> , Without load with 24 V.

<sup>3)</sup> Operating in outdoor condition only with a external protection housing.

## Performance

<b>Maximum range</b>	7 m <sup>1)</sup>
<b>Minimum range</b>	≥ 0 m
<b>Operating range</b>	5 m
<b>Response time</b>	7.1 ms <sup>2)</sup>

<sup>1)</sup> No reserve for environmental issue and deterioration of the diode.

<sup>2)</sup> Without high speed.

## Communication interface

<b>IO-Link</b>	✓, IO-Link V1.1
Data transmission rate	230,4 kbit/s (COM3)
Maximum cable length	20 m
Cycle time	2.3 ms
VendorID	26
DeviceID HEX	800068
DeviceID DEC	8388712
Process data length	32 Byte (TYPE_2_V) <sup>1)</sup>
<b>Analog</b>	✓, Current
<b>Inputs/outputs</b>	2 x analog + 2 x Q (IO-Link)
<b>Analog output (current)</b>	4 mA ... 20 mA
<b>Analog output</b>	Q <sub>A1</sub> , Q <sub>A2</sub>
Number	2
Type	Current output
Current	4 mA ... 20 mA
<b>Digital output</b>	Q <sub>1</sub> , Q <sub>2</sub>
Number	2
<b>Digital input</b>	In <sub>1</sub>
Number	1

<sup>1)</sup> With an IO-Link master with V1.0, fall back to interleaved mode (consisting of TYPE\_1\_1 (ProcessData) and TYPE\_1\_2 (On-request Data)).

## Ambient data

<b>Shock resistance</b>	Continuous shocks 10 g, 16 ms, 1000 shocks Single shocks 15 g, 11 ms 3 per axle
-------------------------	--

<sup>1)</sup> Outdoor mode.

<sup>2)</sup> Light resistance indirect.

<b>Vibration resistance</b>	Sinusoidal oscillation 10-150 Hz 5 g
<b>EMC</b>	EN 60947-5-2
<b>Ambient light immunity</b>	Direct: 150,000 lx <sup>1)</sup> Indirect: 200,000 lx <sup>2)</sup>
<b>Ambient operating temperature</b>	-30 °C ... +55 °C
<b>Ambient temperature, storage</b>	-40 °C ... +70 °C

<sup>1)</sup> Outdoor mode.

<sup>2)</sup> Light resistance indirect.

### Smart Task

<b>Smart Task name</b>	Base logics
------------------------	-------------

### Classifications

<b>ECLASS 5.0</b>	27270910
<b>ECLASS 5.1.4</b>	27270910
<b>ECLASS 6.0</b>	27270910
<b>ECLASS 6.2</b>	27270910
<b>ECLASS 7.0</b>	27270910
<b>ECLASS 8.0</b>	27270910
<b>ECLASS 8.1</b>	27270910
<b>ECLASS 9.0</b>	27270910
<b>ECLASS 10.0</b>	27270910
<b>ECLASS 11.0</b>	27270910
<b>ECLASS 12.0</b>	27270910
<b>ETIM 5.0</b>	EC002549
<b>ETIM 6.0</b>	EC002549
<b>ETIM 7.0</b>	EC002549
<b>ETIM 8.0</b>	EC002549
<b>UNSPSC 16.0901</b>	39121528

Dimensional drawing (Dimensions in mm (inch))

Dimensional drawing



	<b>A</b> <sup>1)</sup>	<b>B</b> <sup>2)</sup>
<b>Strahlabstand 2,5 mm</b>	62,25	17,15
<b>Strahlabstand 5 mm</b>	63,3	16,1
<b>Strahlabstand 10 mm</b>	68,3	16,1
<b>Strahlabstand 20 mm</b>	68,3/78,3 <sup>3)</sup>	16,1
<b>Strahlabstand 25 mm</b>	83,3	16,1
<b>Strahlabstand 30 mm</b>	88,3	16,1
<b>Strahlabstand 50 mm</b>	108,3	16,1

<sup>1)</sup> Abstand: MLG-2 Kante - erster Strahl

<sup>2)</sup> Abstand: MLG-2 Kante - letzter Strahl

<sup>3)</sup> MLG20x-xx**40**: 68,3 mm  
 MLG20x-xx**80**: 78,3 mm

- ① First beam
- ② Last beam
- ③ Detection height (see technical data)

- ④ Beam separation
- ⑤ Optical axis
- ⑥ Status indicator: green, yellow, red LEDs
- ⑦ Connection

## Adjustments

Adjustments



① Status indicator: green, yellow, red LEDs

## Connection type and diagram

Connector M12, 5/8-pin, analog outputs Q<sub>A</sub>

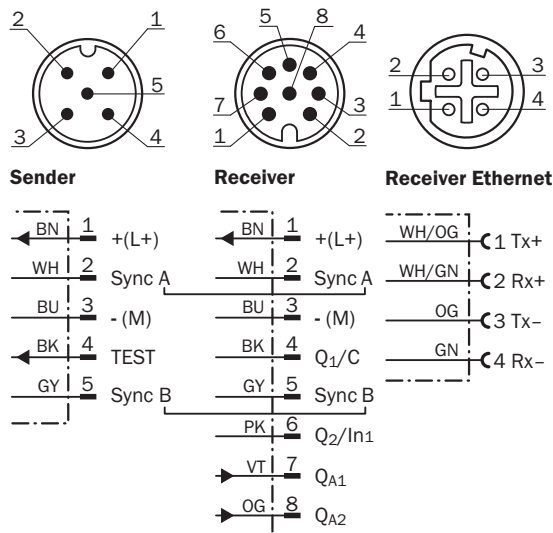

Pin assignment



- ① Connection cable receiver (2096010)
- ② T-piece
- ③ Connection cable (6020664)
- ④ Ethernet Connection cable



### Connection diagram

T-junction, PLC



T-junction, IO-Link-Master



Recommended accessories

Other models and accessories → [www.sick.com/MLG-2](http://www.sick.com/MLG-2)

	Brief description	Type	Part no.
<b>Distributors</b>			
	<ul style="list-style-type: none"> <li>• <b>Connection type head A:</b> Female connector, M12, 5-pin, A-coded</li> <li>• <b>Connection type head B:</b> Female connector, M12, 8-pin, A-coded</li> <li>• <b>Connection type head C:</b> Male connector, M12, 8-pin, A-coded</li> <li>• <b>Note:</b> Male connector M12, 8-pin, to 1 x female connector M12, 8-pin, to 1 x female connector M12, 5-pin, for connecting of a PLC</li> </ul>	SBO-02F12-SM1	6053172
<b>Plug connectors and cables</b>			
	<ul style="list-style-type: none"> <li>• <b>Connection type head A:</b> Female connector, M12, 8-pin, straight</li> <li>• <b>Connection type head B:</b> Flying leads</li> <li>• <b>Signal type:</b> Sensor/actuator cable</li> <li>• <b>Cable:</b> 5 m, 8-wire, PVC</li> <li>• <b>Description:</b> Sensor/actuator cable, special color code, shielded</li> <li>• <b>Connection systems:</b> Flying leads</li> </ul>	DOL-1208-G05MF	6020664
	<ul style="list-style-type: none"> <li>• <b>Connection type head A:</b> Female connector, M12, 5-pin, straight, A-coded</li> <li>• <b>Connection type head B:</b> Male connector, M12, 5-pin, straight, A-coded</li> <li>• <b>Signal type:</b> Sensor/actuator cable</li> <li>• <b>Cable:</b> 5 m, 5-wire, PUR, halogen-free</li> <li>• <b>Description:</b> Sensor/actuator cable, unshielded</li> <li>• <b>Application:</b> Zones with oils and lubricants, Drag chain operation, Robot</li> </ul>	YF2A15-050UB5M2A15	2096010
	<ul style="list-style-type: none"> <li>• <b>Connection type head A:</b> Male connector, M12, 4-pin, straight, D-coded</li> <li>• <b>Connection type head B:</b> Male connector, RJ45, 4-pin, straight</li> <li>• <b>Signal type:</b> Ethernet, PROFINET</li> <li>• <b>Cable:</b> 5 m, 4-wire, PUR, halogen-free</li> <li>• <b>Description:</b> Ethernet, PROFINET, shielded</li> <li>• <b>Application:</b> Drag chain operation, Zones with oils and lubricants</li> </ul>	YM2D24-050PN1MRJA4	2106184
<b>Sensor Integration Gateway</b>			
	<ul style="list-style-type: none"> <li>• <b>Further functions:</b> Web server integrated, USB connection for easy configuration of the SIG200 Sensor Integration Gateway with SOPAS ET, the engineering tool from SICK, logic editor is available for easy configuration of logic functions</li> <li>• <b>Connection CONFIG:</b> 1 x M8, 4-pin female connector, USB 2.0 (USB-A)</li> <li>• <b>Logic editor:</b> yes</li> <li>• <b>Communication interface:</b> IO-Link, USB, Ethernet, PROFINET, REST API</li> <li>• <b>Product category:</b> IO-Link Master</li> </ul>	SIG200-0A0412200	1089794
	<ul style="list-style-type: none"> <li>• <b>Further functions:</b> Web server integrated, USB connection for easy configuration of the SIG200 Sensor Integration Gateway with SOPAS ET, the engineering tool from SICK, logic editor is available for easy configuration of logic functions</li> <li>• <b>Connection CONFIG:</b> 1 x M8, 4-pin female connector, USB 2.0 (USB-A)</li> <li>• <b>Logic editor:</b> yes</li> <li>• <b>Communication interface:</b> IO-Link, USB, Ethernet, REST API</li> <li>• <b>Product category:</b> IO-Link Master</li> </ul>	SIG200-0A0G12200	1102605

## SICK AT A GLANCE

SICK is one of the leading manufacturers of intelligent sensors and sensor solutions for industrial applications. A unique range of products and services creates the perfect basis for controlling processes securely and efficiently, protecting individuals from accidents and preventing damage to the environment.

We have extensive experience in a wide range of industries and understand their processes and requirements. With intelligent sensors, we can deliver exactly what our customers need. In application centers in Europe, Asia and North America, system solutions are tested and optimized in accordance with customer specifications. All this makes us a reliable supplier and development partner.

Comprehensive services complete our offering: SICK LifeTime Services provide support throughout the machine life cycle and ensure safety and productivity.

For us, that is “Sensor Intelligence.”

## WORLDWIDE PRESENCE:

Contacts and other locations –[www.sick.com](http://www.sick.com)