



Product designation

Roller lever
plunger

Product type designation

KBE

General characteristics

Material

Housing
Roller

Polymer
thermoplastic
Plastic

Contact characteristics

Type of contact		2NO Slow action
Thermal current I _{th}	A	10
IEC/EN 60947-5-1 designation		A600 Q300
Rated insulation voltage U _i	V	690
Rated impulse withstand voltage U _{imp}	kV	6
Insulation class		II
Short-circuit protection with fuse	Class/A	10 gG/SC QUICK FUSE
Switching speed	min max	m/s 0.5 1.5
IEC Conventional free air thermal current I _{th}	A	10
Resistance per pole (average value)	mΩ	<10

Mechanical features

Operating head fixing		Locking bayonet insert
Operating torque	Ncm ozin	3 4.25
Tightening torque (Max)		
Switch fixing	Nm lbin	2.5 22.1
Contact terminals	Nm lbin	0.8 7
Body lid screw fixing	Nm lbin	0.8 7
Conductor section		
AWG/Kcmil	min max	16 14
IEC	min max	mm ² 1or 2 mm ² 2.5

Cable connection	Self-releasing screw terminal
Cable entry	M20 on the bottom

Operations

Mechanical life	cycles	<10000000
Mechanical operation	cycles/h	3600

Ambient conditions

Temperature			
Operating temperature			
	min	°C	-25
	max	°C	+70
Storage temperature			
	min	°C	-40
	max	°C	+70

Resistance & Protection

IP degree	Terminals	IP20
	Body housing	IP65
Pollution degree		3

Dimensions

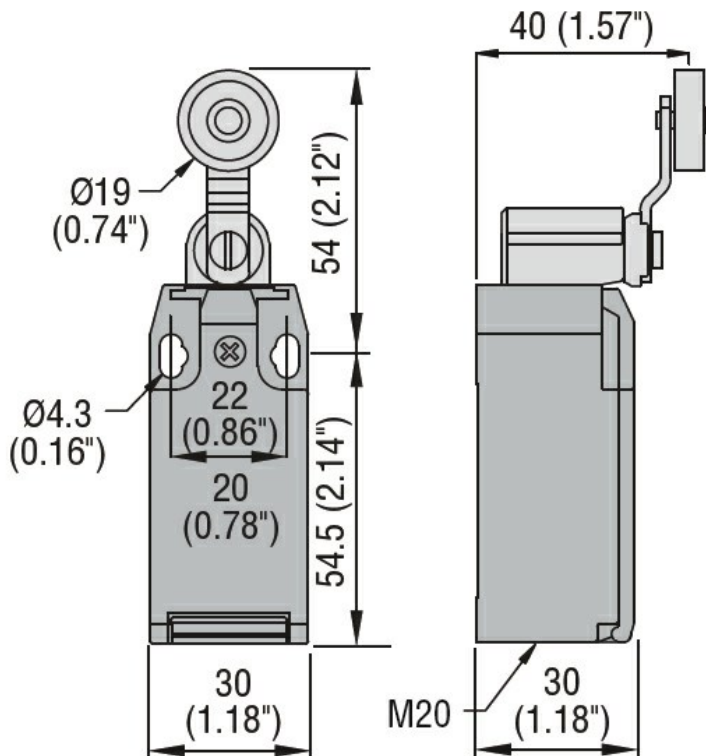

Wiring diagrams

Slow action

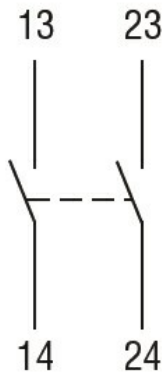

2NO

Certifications and compliance

Compliance

CSA C22.2 n° 14

EN 50047

IEC/EN 60204-1

IEC/EN 60947-1

IEC/EN 60947-5-1

UL508

Certificates

CCC

cULus

EAC

ETIM classification

ETIM 8.0

EC000030 - End
switch