

Product designation	ILLUMINATED selector switch actuator - 3 position
Product type designation	LPCSL13

General characteristics

Colour	Blue
Type of positions	Selector switch
Material	Polyamide
IEC degree of protection	IP66, IP67 and IP69K

Mechanical features

Mechanical life	cycles	1000000
Fixing	Without mounting adapter	
Mounting adapter	LPXAU120	
Weight	g	25

UL technical data

UL degree of protection	Type1, 2, 3R, 4, 4X, 12, 12K
-------------------------	------------------------------

Ambient conditions

Temperature	Operating temperature	min	°C	-25
		max	°C	+70
	Storage temperature	min	°C	-40
		max	°C	+85

Dimensions

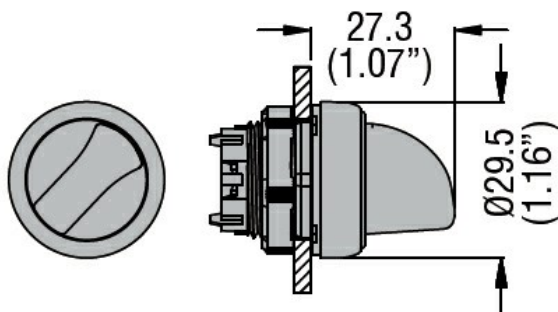

Certifications and compliance

Compliance	CSA C22.2 n° 14
	IEC/EN/BS 60947-1
	IEC/EN/BS 60947-5-1
	UL508

Certificates

CCC

cULus

EAC

RINA

ETIM classification

ETIM 8.0

EC000222 -
Front element for
selector switch