



AFM60A-S1AK004096

AFS/AFM60 SSI

ABSOLUTE ENCODERS

SICK
Sensor Intelligence.

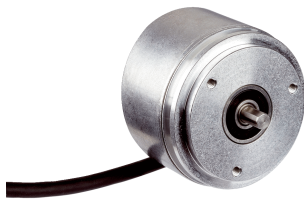

Illustration may differ



Ordering information

Type	Part no.
AFM60A-S1AK004096	1037873

Other models and accessories → www.sick.com/AFS_AFM60_SSI

Detailed technical data

Performance

Number of steps per revolution (max. resolution)	4,096 (12 bit)
Number of revolutions	4,096 (12 bit)
Max. resolution (number of steps per revolution x number of revolutions)	12 bit x 12 bit (4,096 x 4,096)
Error limits G	0.03° ¹⁾
Repeatability standard deviation σ_r	0.002° ²⁾

¹⁾ In accordance with DIN ISO 1319-1, position of the upper and lower error limit depends on the installation situation, specified value refers to a symmetrical position, i.e. deviation in upper and lower direction is the same.

²⁾ In accordance with DIN ISO 55350-13; 68.3% of the measured values are inside the specified area.

Interfaces

Communication interface	SSI
Initialization time	50 ms ¹⁾
Position forming time	< 1 μ s
Code type	Gray
Code sequence parameter adjustable	CW/CCW (V/R) parameter adjustable
Clock frequency	\leq 2 MHz ²⁾
Set (electronic adjustment)	H-active (L = 0 - 3 V, H = 4,0 - U _s V)
CW/CCW (counting sequence when turning)	L-active (L = 0 - 1,5 V, H = 2,0 - U _s V)

¹⁾ Valid positional data can be read once this time has elapsed.

²⁾ Minimum, LOW level (Clock +): 250 ns.

Electrical data

Connection type	Cable, 8-wire, universal, 1.5 m ¹⁾
Supply voltage	4.5 ... 32 V
Power consumption	\leq 0.7 W (without load)
Reverse polarity protection	✓

¹⁾ The universal cable connection is positioned so that it is possible to lay it without bends in a radial or axial direction.

²⁾ This product is a standard product and does not constitute a safety component as defined in the Machinery Directive. Calculation based on nominal load of components, average ambient temperature 40°C, frequency of use 8760 h/a. All electronic failures are considered hazardous. For more information, see document no. 8015532.

MTTFd: mean time to dangerous failure	250 years (EN ISO 13849-1) ²⁾
--	--

¹⁾ The universal cable connection is positioned so that it is possible to lay it without bends in a radial or axial direction.

²⁾ This product is a standard product and does not constitute a safety component as defined in the Machinery Directive. Calculation based on nominal load of components, average ambient temperature 40 °C, frequency of use 8760 h/a. All electronic failures are considered hazardous. For more information, see document no. 8015532.

Mechanical data

Mechanical design	Solid shaft, Servo flange
Shaft diameter	6 mm
Shaft length	10 mm
Weight	0.3 kg ¹⁾
Shaft material	Stainless steel
Flange material	Aluminum
Housing material	Aluminum die cast
Start up torque	< 0.5 Ncm (+20 °C)
Operating torque	< 0.3 Ncm (+20 °C)
Permissible shaft loading	80 N (radial) 40 N (axial)
Operating speed	≤ 9,000 min ⁻¹ ²⁾
Moment of inertia of the rotor	6.2 gcm ²
Bearing lifetime	3.0 x 10 ⁹ revolutions
Angular acceleration	≤ 500,000 rad/s ²

¹⁾ Based on devices with male connector.

²⁾ Allow for self-heating of 3.3 K per 1,000 rpm when designing the operating temperature range.

Ambient data

EMC	According to EN 61000-6-2 and EN 61000-6-3 ¹⁾
Enclosure rating	IP65, shaft side (IEC 60529) IP67, housing side (IEC 60529) ²⁾
Permissible relative humidity	90 % (Condensation not permitted)
Operating temperature range	-40 °C ... +100 °C ³⁾
Storage temperature range	-40 °C ... +100 °C, without package
Resistance to shocks	60 g, 6 ms (EN 60068-2-27)
Resistance to vibration	20 g, 10 Hz ... 2,000 Hz (EN 60068-2-6)

¹⁾ EMC according to the standards quoted is achieved if shielded cables are used.

²⁾ For devices with male connector: with mounted mating connector.

³⁾ Stationary position of the cable.

Classifications

eCI@ss 5.0	27270502
eCI@ss 5.1.4	27270502
eCI@ss 6.0	27270590
eCI@ss 6.2	27270590
eCI@ss 7.0	27270502
eCI@ss 8.0	27270502

eCl@ss 8.1	27270502
eCl@ss 9.0	27270502
eCl@ss 10.0	27270502
eCl@ss 11.0	27270502
eCl@ss 12.0	27270502
ETIM 5.0	EC001486
ETIM 6.0	EC001486
ETIM 7.0	EC001486
ETIM 8.0	EC001486
UNSPSC 16.0901	41112113

Dimensional drawing (Dimensions in mm (inch))

Servo flange, cable

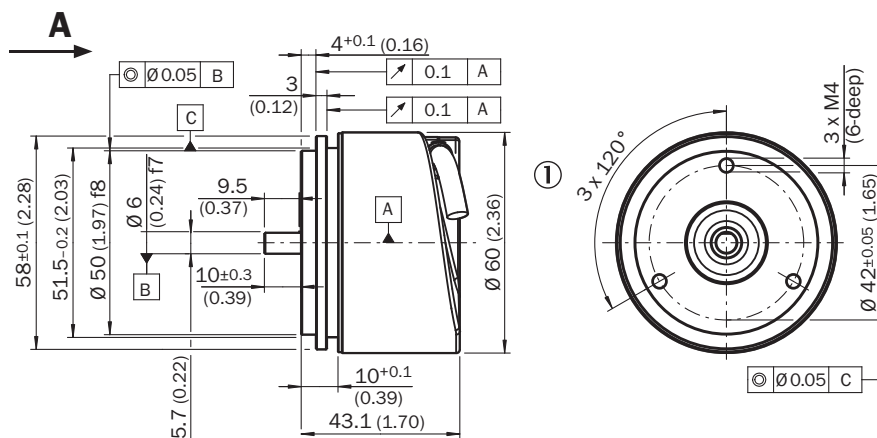

General tolerances according to DIN ISO 2768-mk

① Cable diameter = 5.6 mm +/- 0.2 mm bend radius = 30 mm

Attachment specifications

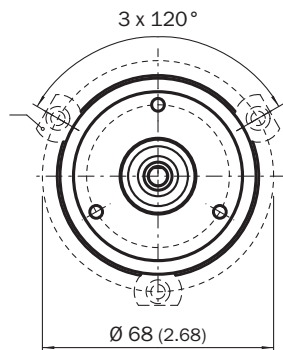

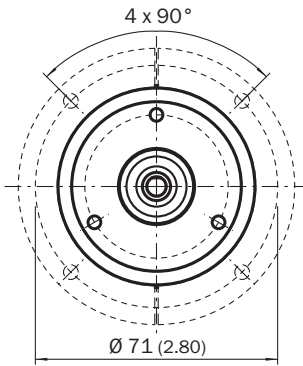

PIN assignment

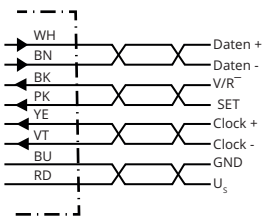

PIN	Wire colors (cable connection)	Signal	Explanation
1	Brown	Data -	Interface signals
2	White	Data +	Interface signals
3	Black	V/R	Sequence in direction of rotation
4	Pink	SET	Electronic adjustment Interface signals
5	Yellow	Clock +	Interface signals
6	Purple	Clock -	Interface signals
7	Blue	GND	Ground connection
8	Red	U _s	Operating voltage
		Screen	Screen connected to housing on encoder side. Connected to ground on control side.



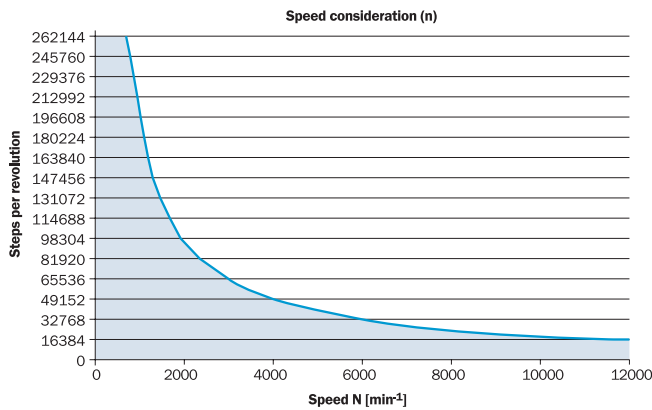



Diagrams







The maximum speed is also dependent on the shaft type.

Recommended accessories

Other models and accessories → www.sick.com/AFS_AFM60_SSI

	Brief description	Type	Part no.
Other mounting accessories			
	Servo clamps, large, for servo flange (clamps, eccentric fastener), 3 pcs, without mounting material, without mounting hardware	BEF-WK-SF	2029166
Plug connectors and cables			
	Head A: male connector, M12, 8-pin, straight, A-coded Cable: Incremental, shielded	STE-1208-GA01	6044892
	Head A: male connector, M23, 12-pin, straight Cable: HIPERFACE [®] , SSI, Incremental, RS-422, shielded	STE-2312-G	6027537
	Head A: male connector, M23, 12-pin, straight Cable: HIPERFACE [®] , SSI, Incremental, shielded	STE-2312-G01	2077273
		STE-2312-GX	6028548
Shaft adaptation			
	Bellows coupling, shaft diameter 6 mm / 6 mm, maximum shaft offset: radial ± 0.25 mm, axial ± 0.4 mm, angular +/- 4°; max. speed 10,000 rpm, -30 °C to +120 °C, max. torque 120 Ncm; material: stainless steel bellows, aluminum hub	KUP-0606-B	5312981
	Cross-slotted coupling, shaft diameter 6 mm / 6 mm, maximum shaft offset: radial ± 0.3 mm, axial ± 0.2 mm, angle ± 3°; max. speed 10,000 rpm, -10° to +80 °C, max. torque 80 Ncm; material: fiber-glass reinforced polyamide, aluminum hub	KUP-0606-S	2056406
	Bar coupling, shaft diameter 6 mm / 8 mm, maximum shaft offset radial ± 0.3 mm, axial ± 0.2 mm, angle ± 3°, max. speed 10,000 rpm, torsion spring rigidity 38 Nm/wheel; material: fiber-glass reinforced polyamide, aluminum hub	KUP-0608-S	5314179

	Brief description	Type	Part no.
	Bellows coupling, shaft diameter 6 mm / 10 mm, maximum shaft offset: radial ± 0.25 mm, axial ± 0.4 mm, angular $\pm 4^\circ$; max. speed 10,000 rpm, -30°C to $+120^\circ\text{C}$, max. torque 120 Ncm; material: stainless steel bellows, aluminum hub	KUP-0610-B	5312982
	Double loop coupling, shaft diameter 6 mm / 10 mm, max. shaft offset: radially ± 2.5 mm, axially ± 3 mm, angle ± 10 degrees; max. speed 3.000 rpm, -30 to $+80$ degrees Celsius, torsional spring stiffness of 25 Nm/rad	KUP-0610-D	5326697
	Spring washer coupling, shaft diameter 6 mm / 10 mm, Maximum shaft offset: radial ± 0.3 mm, axial ± 0.4 mm, angular $\pm 2.5^\circ$; max. speed 12,000 rpm, -10° to $+80^\circ\text{C}$, max. torque 60 Ncm; material: aluminum flange, glass fiber-reinforced polyamide membrane and hardened steel coupling pin	KUP-0610-F	5312985
	Claw coupling, shaft diameter 6 mm / 10 mm, damping element 80 shore blue, maximum shaft offset: radial ± 0.22 mm, axial ± 1 mm angular $\pm 1.3^\circ$, max. speed 19,000 rpm, angle of twist max. 10° , -30°C to $+80^\circ\text{C}$, max. torque 800 Ncm, tightening torque of screws: ISO 4029 150 Ncm, material: aluminum flange, damping element: polyurethane	KUP-0610-J	2127056
	Bar coupling, shaft diameter 6 mm / 10 mm, max. shaft offset: radial $\pm 0,3$ mm, axial $\pm 0,3$ mm, angular $\pm 3^\circ$; max. speed 10.000 rpm, -10° to $+80^\circ\text{C}$, max. torque: 80 Ncm, material: fiber-glass reinforced polyamide, aluminum hub	KUP-0610-S	2056407

SICK AT A GLANCE

SICK is one of the leading manufacturers of intelligent sensors and sensor solutions for industrial applications. A unique range of products and services creates the perfect basis for controlling processes securely and efficiently, protecting individuals from accidents and preventing damage to the environment.

We have extensive experience in a wide range of industries and understand their processes and requirements. With intelligent sensors, we can deliver exactly what our customers need. In application centers in Europe, Asia and North America, system solutions are tested and optimized in accordance with customer specifications. All this makes us a reliable supplier and development partner.

Comprehensive services complete our offering: SICK LifeTime Services provide support throughout the machine life cycle and ensure safety and productivity.

For us, that is “Sensor Intelligence.”

WORLDWIDE PRESENCE:

Contacts and other locations –www.sick.com