



WLG4SC-3P2232VA00

W4

MINIATURE PHOTOELECTRIC SENSORS

SICK
Sensor Intelligence.



Illustration may differ

Ordering information

Type	Part no.
WLG4SC-3P2232VA00	1097830

Other models and accessories → www.sick.com/W4



Detailed technical data

Features

Functional principle	Photoelectric retro-reflective sensor
Functional principle detail	Autocollimation
Sensing range max.	0 m ... 5 m ¹⁾
Sensing range	0 m ... 3 m ¹⁾
Polarisation filters	Yes
Emitted beam	
Light source	PinPoint LED ²⁾
Type of light	Visible red light
Light spot size (distance)	Ø 45 mm (1.5 m)
Key LED figures	
Wave length	650 nm
Adjustment	Single teach-in button
Special applications	Hygienic and washdown zones, Detecting transparent objects
Housing design	Washdown
Pin 2 configuration	External input, Teach-in input, Sender off input, Detection output, logic output, Device contamination alarm output

¹⁾ Reflector PL80A.

²⁾ Average service life: 100,000 h at T_U = +25 °C.

AutoAdapt	✓
------------------	---

1) Reflector PL80A.

2) Average service life: 100,000 h at $T_U = +25 \text{ °C}$.

Safety-related parameters

MTTF_D	1,222 years
DC_{avg}	0 %

Communication interface

IO-Link	✓, COM2 (38,4 kBaud)
Data transmission rate	COM2 (38,4 kBaud)
Cycle time	2.3 ms
Process data length	16 Bit
Process data structure	Bit 0 = switching signal Q_{L1} Bit 1 = switching signal Q_{L2} Bit 2 ... 15 = empty
VendorID	26
DeviceID HEX	0x8001CF
DeviceID DEC	8389071

Electrical data

Supply voltage U_B	10 V DC ... 30 V DC ¹⁾
Ripple	< 5 V _{pp} ²⁾
Current consumption	30 mA ³⁾
Protection class	III
Digital output	
Type	PNP ⁴⁾
Switching mode	Light/dark switching
Output current I_{max}	≤ 100 mA
Response time	< 0,5 ms ⁵⁾
Repeatability (response time)	150 μs
Switching frequency	1,000 Hz ⁶⁾
Attenuation along light beam	> 8 %
Output function	Complementary
Circuit protection	A, B, C ^{7) 8) 9)}

1) Limit values, reverse-polarity protected, operation in short-circuit protected network: max. 8 A.

2) May not exceed or fall below U_V tolerances.

3) Without load.

4) Pin 4: This switching output must not be connected to another output.

5) Signal transit time with resistive load.

6) With light/dark ratio 1:1.

7) A = V_S connections reverse-polarity protected.

8) B = inputs and output reverse-polarity protected.

9) C = interference suppression.

10) Valid for $Q \setminus$ on Pin2, if configured with software.

11) With light / dark ratio 1:1, valid for $Q \setminus$ on Pin2, if configured with software.

Response time Q/ on Pin 2	300 μ s ... 450 μ s ^{10) 5)}
Switching frequency Q / to pin 2	1,000 Hz ¹¹⁾

- 1) Limit values, reverse-polarity protected, operation in short-circuit protected network: max. 8 A.
- 2) May not exceed or fall below U_V tolerances.
- 3) Without load.
- 4) Pin 4: This switching output must not be connected to another output.
- 5) Signal transit time with resistive load.
- 6) With light/dark ratio 1:1.
- 7) A = V_S connections reverse-polarity protected.
- 8) B = inputs and output reverse-polarity protected.
- 9) C = interference suppression.
- 10) Valid for Q \ on Pin2, if configured with software.
- 11) With light / dark ratio 1:1, valid for Q \ on Pin2, if configured with software.

Mechanical data

Housing	Rectangular
Design detail	Slim
Dimensions (W x H x D)	15.25 mm x 44.9 mm x 22.2 mm
Connection	Male connector M8, 4-pin ¹⁾
Material	
Housing	Stainless steel, Stainless steel V4A (1.4404, 316L)
Front screen	Plastic, PMMA
Weight	40 g

- 1) Max. tightening torque: 0.6 Nm.

Ambient data

Enclosure rating	IP66 IP67 IP68 IP69K ¹⁾
Ambient operating temperature	-30 °C ... +70 °C ²⁾ -30 °C ... +60 °C
Ambient temperature, storage	-30 °C ... +75 °C
UL File No.	NRKH.E181493 & NRKH7.E181493

- 1) Only in case of correctly mounted IP69K connecting cable.
- 2) At $UV \leq 24$ V and $IA < 30$ mA.

Smart Task

Smart Task name	Base logics
Logic function	Direct AND OR WINDOW Hysteresis
Timer function	Deactivated On delay Off delay

- 1) SIO Direct: sensor operation in standard I/O mode without IO-Link communication and without using internal sensor logic or time parameters (set to "direct"/"deactivated").
- 2) SIO Logic: Sensor operation in standard I/O mode without IO-Link communication. Sensor-internal logic or timing parameters plus Automation Functions used.
- 3) IOL: Sensor operation with full IO-Link communication and usage of logic, timing and Automation Function parameters.

	ON and OFF delay Impulse (one shot)
Inverter	Yes
Switching frequency	SIO Direct: 1000 Hz SIO Logic: 1000 Hz IOL: 900 Hz
Response time	SIO Direct: 300 µs ... 450 µs ¹⁾ SIO Logic: 500 µs ... 600 µs ²⁾ IOL: 500 µs ... 900 µs ³⁾
Repeatability	SIO Direct: 150 µs ¹⁾ SIO Logic: 150 µs ²⁾ IOL: 400 µs ³⁾
Switching signal	
Switching signal Q _{L1}	Switching output
Switching signal Q _{L2}	Switching output

¹⁾ SIO Direct: sensor operation in standard I/O mode without IO-Link communication and without using internal sensor logic or time parameters (set to "direct"/"deactivated").

²⁾ SIO Logic: Sensor operation in standard I/O mode without IO-Link communication. Sensor-internal logic or timing parameters plus Automation Functions used.

³⁾ IOL: Sensor operation with full IO-Link communication and usage of logic, timing and Automation Function parameters.

Diagnosis

Device status	Yes
Quality of teach	Yes
Quality of run	Yes, Contamination display

Classifications

ECLASS 5.0	27270902
ECLASS 5.1.4	27270902
ECLASS 6.0	27270902
ECLASS 6.2	27270902
ECLASS 7.0	27270902
ECLASS 8.0	27270902
ECLASS 8.1	27270902
ECLASS 9.0	27270902
ECLASS 10.0	27270902
ECLASS 11.0	27270902
ECLASS 12.0	27270902
ETIM 5.0	EC002717
ETIM 6.0	EC002717
ETIM 7.0	EC002717
ETIM 8.0	EC002717
UNSPSC 16.0901	39121528

Connection diagram

Cd-367

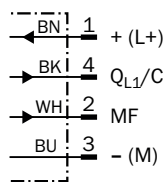

Characteristic curve

WL4S-3, WLG4S-3, 5 m

Operating reserve

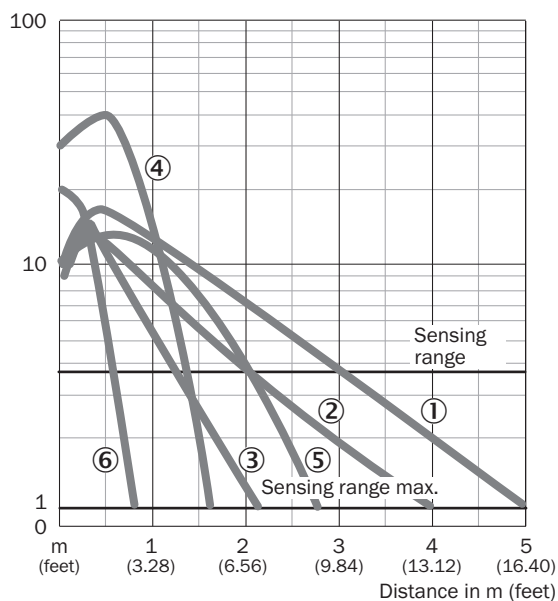

- ① Reflector PL80A
- ② Reflector PL40A
- ③ Reflector PL20A
- ④ PL10F reflector
- ⑤ Reflector P250 CHEM
- ⑥ Reflective tape REF-IRF-56

Sensing range diagram

WL4S-3, WLG4S-3, 5 m

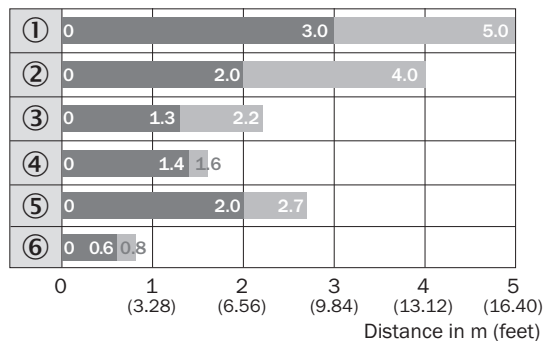

■ Sensing range ■ Sensing range max.

- ① Reflector PL80A
- ② Reflector PL40A
- ③ Reflector PL20A
- ④ PL10F reflector
- ⑤ Reflector P250 CHEM
- ⑥ Reflective tape REF-IRF-56

Dimensional drawing (Dimensions in mm (inch))

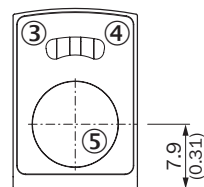
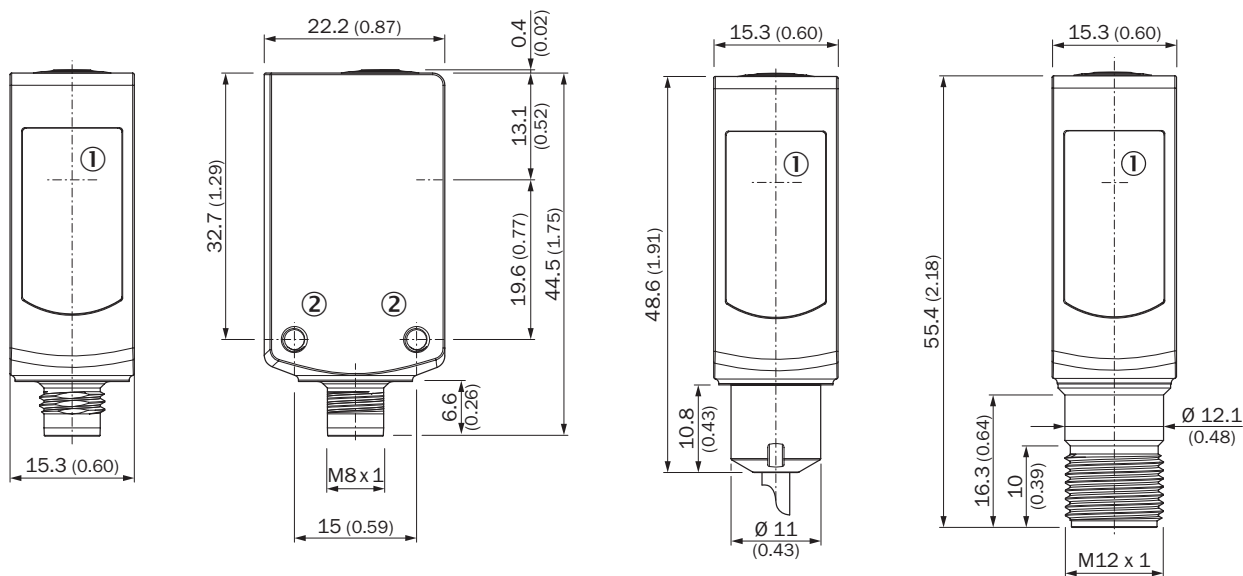

WL4S-3V, WLG4S-3V, with single teach-in button



- ① Center of optical axis
- ② Threaded mounting hole M3
- ③ LED indicator yellow: Status of received light beam
- ④ LED indicator green: Supply voltage active
- ⑤ Teach-in button

Recommended accessories

Other models and accessories → www.sick.com/W4

	Brief description	Type	Part no.
Mounting brackets and plates			
	Mounting bracket for floor mounting, Stainless steel 1.4571, mounting hardware included	BEF-W4-B	2051630
Reflectors			
	Chemically resistant, screw connection, 52 mm x 61 mm, plastic, Screw-on, 2 hole mounting	P250 CHEM	5321097
Others			
	<ul style="list-style-type: none"> • Connection type head A: Female connector, M8, 4-pin, straight • Connection type head B: Flying leads • Signal type: Sensor/actuator cable • Cable: 5 m, 4-wire, PVC • Description: Sensor/actuator cable, unshielded • Connection systems: Flying leads • Note: This product is generally resistant to chemical cleaning agents (see ECOLAB). Please do not use cleaning agents of any other Kind., Not resistant against lactic acid & hydrogen peroxide (H2O2) • Application: Hygienic and washdown zones 	DOL-0804-G05MNI	6059194

Recommended services

Additional services → www.sick.com/W4

	Type	Part no.
Function Block Factory		
<ul style="list-style-type: none"> • Description: The Function Block Factory supports common programmable logic controllers (PLCs) from various manufacturers, such as Siemens, Beckhoff, Rockwell Automation and B&R. More information on the FBF can be found here. • Note: You can configure your function block at Function Block Factory. As a login please use your SICK ID. 	Function Block Factory	On request

SICK AT A GLANCE

SICK is one of the leading manufacturers of intelligent sensors and sensor solutions for industrial applications. A unique range of products and services creates the perfect basis for controlling processes securely and efficiently, protecting individuals from accidents and preventing damage to the environment.

We have extensive experience in a wide range of industries and understand their processes and requirements. With intelligent sensors, we can deliver exactly what our customers need. In application centers in Europe, Asia and North America, system solutions are tested and optimized in accordance with customer specifications. All this makes us a reliable supplier and development partner.

Comprehensive services complete our offering: SICK LifeTime Services provide support throughout the machine life cycle and ensure safety and productivity.

For us, that is “Sensor Intelligence.”

WORLDWIDE PRESENCE:

Contacts and other locations –www.sick.com