

Part number

# CZP 15 L2



Surface mounting housing, IL-BRID series, with 1 lever, Pg16 x 2 cable entry, size "49.16"

#### Product description

<b>Product type</b>	Surface mounting housing
<b>Series</b>	IL-BRID
<b>Closing type</b>	With 1 lever
<b>Size</b>	Size 49.16
<b>Cable entry</b>	With cable entry Pg16 x 2

#### Technical data

<b>IP degree of protection</b>	IP65 / IP66 / IP69
--------------------------------	--------------------

#### Further technical details

<b>Weight</b>	150,00 g
<b>Operating temperature range (min, max)</b>	-40°C...+125°C

#### Material properties

<b>Other materials</b>	Lever: Polyamide (PA) and Stainless steel core
<b>Colour</b>	RAL 7040 grey
<b>RoHs conformity</b>	Compliant
<b>China RoHs - EFUP</b>	E
<b>REACH SVHC substances</b>	No

#### Approvals / Standards

<b>UL</b>	ECBT2
<b>cUL</b>	ECBT8

#### General ordering information

<b>EAN13 code</b>	8015747044653
-------------------	---------------

#### Packaging Information

<b>Packaging length</b>	270,00 mm
<b>Packaging height</b>	130,00 mm
<b>Packaging width</b>	135,00 mm
<b>Packaging weight</b>	1,67 kg
<b>Packaging volume</b>	4,74 dm <sup>3</sup>
<b>Packaging description</b>	Carton box
<b>Packaging quantity</b>	10 Pcs
<b>Packaging EAN code</b>	8015747171960
<b>Sub-packaging weight</b>	0,84 kg
<b>Sub-packaging description</b>	Plastic packaging
<b>Sub-packaging quantity</b>	5 Pcs
<b>Sub-packaging EAN barcode</b>	8015747171977

Part number

# CZP 15 L2



Catalogue drawings

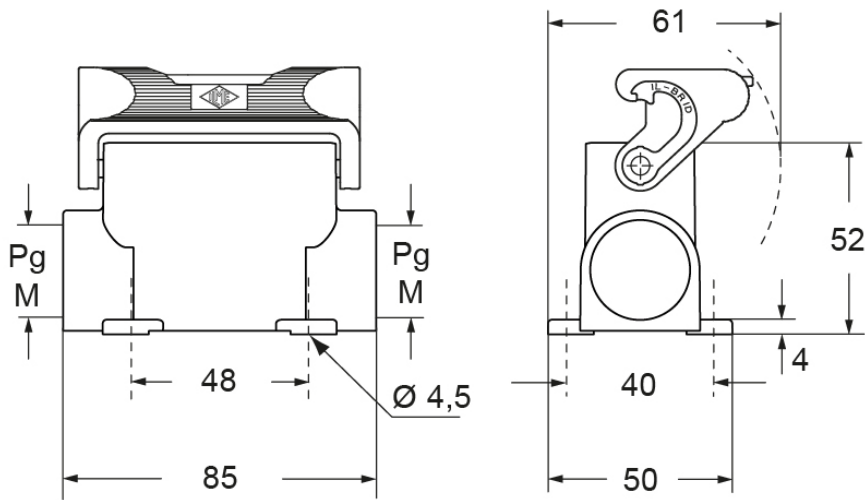

## Notes

Dimensions shown in mm are not binding and may be changed without notice.