

1SNK708031R0000 ✓ ACTIVE

ENTRELEC | ENTRELEC SNK

TE Internal #: 1SNK708031R0000

Modular Terminal Blocks, Feed-Through, PI-Spring Terminal Block,
Orange, Product Spacing .315 in [8 mm], 3 Position, DIN Rail,
ENTRELEC SNK

[View on TE.com >](#)



Connectors > Terminal Blocks & Strips > Modular Terminal Blocks



Block Function: **Feed-Through**

Modular Terminal Block Product Type: **PI-Spring Terminal Block**

Rated Cross Section: **6 mm²**

Primary Product Color: **Orange**

Features

Product Type Features

Modular Terminal Block Product Type	PI-Spring Terminal Block
-------------------------------------	--------------------------

Configuration Features

Gauge Type	A5 & 3.9 mm Dia.
Number of Levels	1
Number of Circuits	1
Block Function	Feed-Through
Number of Positions	3

Electrical Characteristics

Impulse Withstanding Voltage Rating (IEC)	8000 V
Current Rating (CSA)	50 A
Power Loss	1 W
Short-Time Withstanding Current Rating @ 1s	720 A
Voltage Rating (IEC)	1000 V
Operating Voltage Rating (UL & CSA) (Max) - Main Circuit	600 V
Voltage Rating (CSA)	600 V

Dielectric Test Voltage	2200 V
Current Rating (UL)	50 A
Current Rating (IEC)	41 A

Body Features

Product Weight	16.7 g[.657 oz]
Primary Product Color	Orange

Mechanical Attachment

DIN Rail Mounting Type	TH35-15, TH35-7.5
Connector Mounting Type	DIN Rail

Housing Features

Housing Material	Polyamide
------------------	-----------

Dimensions

Main Circuit Capacity - 1 Rigid Stranded Conductor per Spring Clamp	.5 – 10 mm ²
Main Circuit Capacity - Twin Ferrule per Spring Clamp	.5 – 1.5 mm ²
Main Circuit Capacity - 1 Flexible Conductor per Spring Clamp	.5 – 6 mm ²
Wire Stripping Length	12.5 mm[.492 in]
Main Circuit Capacity - 1 Non-Insulated Ferrule per Spring Clamp	.5 – 6 mm ²
Main Circuit Capacity - 1 Insulated Ferrule per Spring Clamp	24 – 10 AWG
Tool Size	3.5 mm[.138 in]
Product Depth	41.9 mm
Product Length	41.9 mm
Product Height	79.1 mm
Rated Cross Section	6 mm ²
Product Spacing	8 mm[.315 in]

Usage Conditions

Storage Temperature Range	-55 – 110 °C[-67 – 230 °F]
Installation Temperature Range	-5 – 40 °C[23 – 104 °F]
Operating Temperature Range	-55 – 110 °C[-67 – 230 °F]

Industry Standards

IP Rating	IP20
UL Flammability Rating	UL 94V-0

Product Compliance



[For compliance documentation, visit the product page on TE.com>](#)

EU RoHS Directive 2011/65/EU	Compliant
EU ELV Directive 2000/53/EC	Compliant
China RoHS 2 Directive MIIT Order No 32, 2016	No Restricted Materials Above Threshold
EU REACH Regulation (EC) No. 1907/2006	Current ECHA Candidate List: JUNE 2022 (224) Candidate List Declared Against: JUNE 2022 (224) Does not contain REACH SVHC
Halogen Content	Low Halogen - Br, Cl, F, I < 900 ppm per homogenous material. Also BFR/CFR/PVC Free
Solder Process Capability	Not reviewed for solder process capability

Product Compliance Disclaimer

This information is provided based on reasonable inquiry of our suppliers and represents our current actual knowledge based on the information they provided. This information is subject to change. The part numbers that TE has identified as EU RoHS compliant have a maximum concentration of 0.1% by weight in homogenous materials for lead, hexavalent chromium, mercury, PBB, PBDE, DBP, BBP, DEHP, DIBP, and 0.01% for cadmium, or qualify for an exemption to these limits as defined in the Annexes of Directive 2011/65/EU (RoHS2). Finished electrical and electronic equipment products will be CE marked as required by Directive 2011/65/EU. Components may not be CE marked. Additionally, the part numbers that TE has identified as EU ELV compliant have a maximum concentration of 0.1% by weight in homogenous materials for lead, hexavalent chromium, and mercury, and 0.01% for cadmium, or qualify for an exemption to these limits as defined in the Annexes of Directive 2000/53/EC (ELV). Regarding the REACH Regulation, the information TE provides on SVHC in articles for this part number is based on the latest European Chemicals Agency (ECHA) 'Guidance on requirements for substances in articles' posted at this URL: <https://echa.europa.eu/guidance-documents/guidance-on-reach>

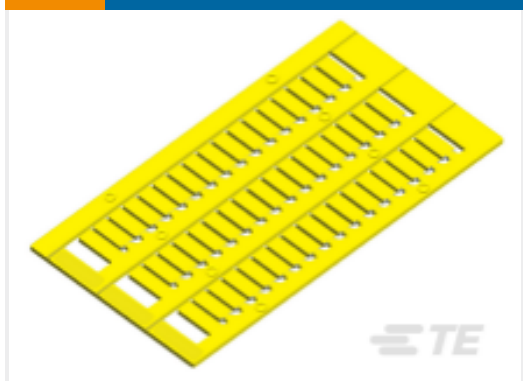
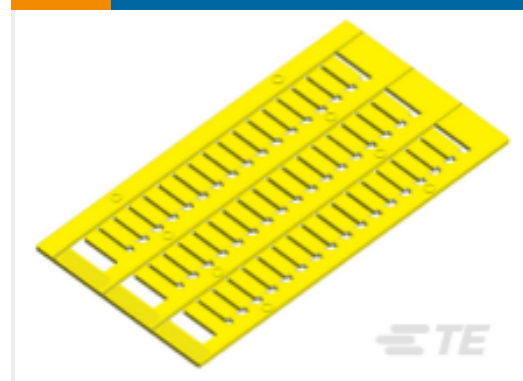
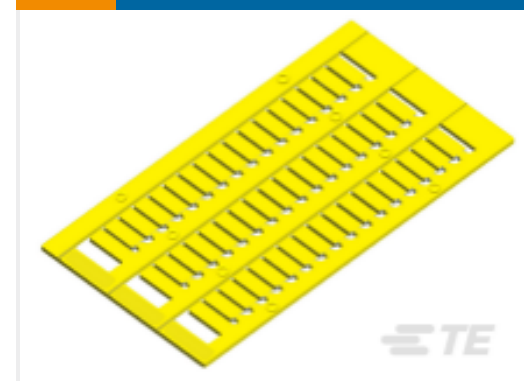
Compatible Parts

 <p>TE Part # 1SNK140004R0000 MC512-YL</p>	 <p>TE Part # 1SNK150004R0000 MC612-YL</p>	 <p>TE Part # 1SNK160004R0000 MC812-YL</p>	 <p>TE Part # 1SNK708911R0000 EK6-3P</p>
---	--	---	---

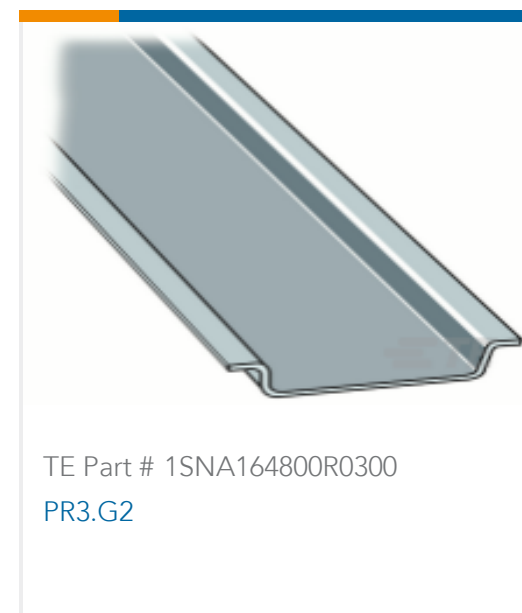

Also in the Series | **ENTRELEC SNK**



Customers Also Bought



TE Part #1546477-2
2P .433" DR BARRIER,W/WASHER



TE Part #1SNK505911R0000
ES6-4S



TE Part #1SNK708911R0000
EK6-3P



TE Part #1SNK900107R0000
CS-R3



TE Part #1SNK908302R0000
JB8-2



TE Part #61622-1
045SQ POST REC 24-20 010PTPBR



TE Part #5-1393127-0
PRD-11DH0-48=PRD

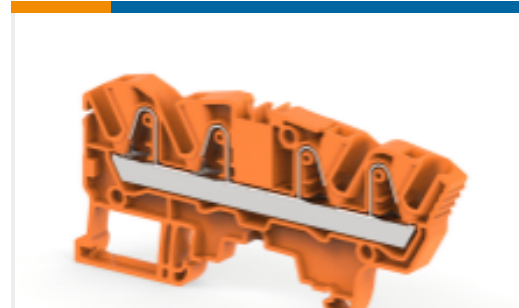

TE Part #1SNK706032R0000
ZK4-4P-OR

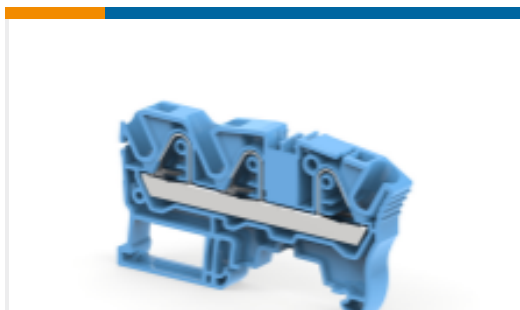

TE Part #1SNK708021R0000
ZK6-3P-BL



TE Part #1SNK708151R0000
ZK6-PE-3P

Documents

CAD Files

3D PDF

3D

Customer View Model

[ENG_CVM_CVM_1SNK708031R0000_A.2d_dxf.zip](#)

English

Customer View Model

[ENG_CVM_CVM_1SNK708031R0000_A.3d_igs.zip](#)

English

Customer View Model

[ENG_CVM_CVM_1SNK708031R0000_A.3d_stp.zip](#)

English

By downloading the CAD file I accept and agree to the [Terms and Conditions](#) of use.

Datasheets & Catalog Pages

[ENTRELEC Terminal Block - Master Catalog](#)

English

[ZK6-3P-OR](#)

English



SNK SERIES TERMINAL BLOCKS

English

[ENTRELEC Terminal Blocks Catalogue \(RUS\)](#)

[Agency Approvals](#)

[Agency Approval Document](#)

English