



Product designation				Power contactor
Product type designation				BF38
Contact characteristics				
Number of poles	Nr.			3
Rated insulation voltage U _i IEC/EN	V			690
Rated impulse withstand voltage U _{imp}	kV			6
Operational frequency	min	Hz		25
	max	Hz		400
IEC Conventional free air thermal current I _{th}	A			56
Operational current I _e	AC-1 (≤40°C)	A		56
	AC-1 (≤40°C) with 16mm ² wire and fork end lug	A		60
	AC-1 (≤55°C)	A		45
	AC-1 (≤55°C) with 16mm ² wire and fork end lug	A		48
	AC-1 (≤70°C)	A		40
	AC-1 (≤70°C) with 16mm ² wire and fork end lug	A		42
	AC-3 (≤440V ≤55°C)	A		38
Rated operational power AC-3 (T≤55°C)	AC-4 (400V)	A		15.5
	230V	kW		11
	400V	kW		18.5
	415V	kW		18.5
	440V	kW		18.5
	500V	kW		20
	690V	kW		22
Rated operational power AC-1 (T≤40°C)	230V	kW		21
	400V	kW		36
	500V	kW		45
	690V	kW		62
	IEC max current I _e in DC1 with L/R ≤ 1ms with 1 poles in series	≤24V	A	
48V		A		30
75V		A		23
110V		A		8
220V		A		–
IEC max current I _e in DC1 with L/R ≤ 1ms with 2 poles in series		≤24V	A	
	48V	A		34
	75V	A		29
	110V	A		32
	220V	A		4
	IEC max current I _e in DC1 with L/R ≤ 1ms with 3 poles in series	≤24V	A	

	48V	A	34
	75V	A	33
	110V	A	34
	220V	A	30
<hr/>			
IEC max current Ie in DC1 with L/R ≤ 1ms with 4 poles in series			
	≤24V	A	36
	48V	A	34
	75V	A	33
	110V	A	34
	220V	A	38
<hr/>			
IEC max current Ie in DC3-DC5 with L/R ≤ 15ms with 1 poles in series			
	≤24V	A	24
	48V	A	20
	75V	A	17
	110V	A	2,5
	220V	A	–
<hr/>			
IEC max current Ie in DC3-DC5 with L/R ≤ 15ms with 2 poles in series			
	≤24V	A	28
	48V	A	25
	75V	A	22
	110V	A	18
	220V	A	3
<hr/>			
IEC max current Ie in DC3-DC5 with L/R ≤ 15ms with 3 poles in series			
	≤24V	A	32
	48V	A	28
	75V	A	28
	110V	A	23
	220V	A	25
<hr/>			
IEC max current Ie in DC3-DC5 with L/R ≤ 15ms with 4 poles in series			
	≤24V	A	32
	48V	A	28
	75V	A	28
	110V	A	23
	220V	A	15
<hr/>			
Short-time allowable current for 10s (IEC/EN60947-1)		A	320
<hr/>			
Protection fuse			
	gG (IEC)	A	63
	aM (IEC)	A	40
<hr/>			
Making capacity (RMS value)		A	380
<hr/>			
Breaking capacity at voltage			
	440V	A	304
	500V	A	240
	690V	A	192
<hr/>			
Resistance per pole (average value)		mΩ	2
<hr/>			
Power dissipation per pole (average value)			
	Ith	W	6
	AC-3	W	2.9
<hr/>			
Tightening torque for terminals			
	min	Nm	2.5
	max	Nm	3
	min	Ibin	1.8
	max	Ibin	2.2
<hr/>			
Tightening torque for coil terminal			

	min	Nm	0.8
	max	Nm	1
	min	Ibin	0.8
	max	Ibin	0.74
Max number of wires simultaneously connectable		Nr.	2
Conductor section			
AWG/Kcmil			
	max		6
Flexible w/o lug conductor section			
	min	mm ²	2.5
	max	mm ²	16
Flexible c/w lug conductor section			
	min	mm ²	1
	max	mm ²	10
Flexible with insulated spade lug conductor section			
	min	mm ²	1
	max	mm ²	10
Power terminal protection according to IEC/EN 60529			IP20 when properly wired
Mechanical features			
Operating position		normal allowable	Vertical plan ±30°
Fixing			Screw / DIN rail 35mm
Weight		g	423
Conductor section			
AWG/kcmil conductor section			
	max		6
Operations			
Mechanical life		cycles	20000000
Electrical life		cycles	1400000
Safety related data			
Performance level B10d according to EN/ISO 13489-1			
	rated load	cycles	1400000
	mechanical load	cycles	20000000
Mirror contacts according to IEC/EN 60947-4-1			yes
EMC compatibility			yes
AC coil operating			
Rated AC voltage at 60Hz		V	120
AC operating voltage			
of 60Hz coil powered at 60Hz			
pick-up	min	%Us	80
	max	%Us	110
drop-out	min	%Us	20
	max	%Us	55
AC average coil consumption at 20°C			
of 60Hz coil powered at 60Hz			
	in-rush	VA	75
	holding	VA	9
Dissipation at holding ≤20°C 50Hz		W	2.5
Max cycles frequency			

Mechanical operation cycles/h 3600

Operating times

Average time for Us control
in AC

Closing NO	min	ms	8
	max	ms	24
Opening NO	min	ms	5
	max	ms	15
Closing NC	min	ms	9
	max	ms	20
Opening NC	min	ms	9
	max	ms	17

UL technical data

Full-load current (FLA) for three-phase AC motor

at 480V	A	40
at 600V	A	32

Yielded mechanical performance

for single-phase AC motor

110/120V	HP	3
230V	HP	7.5

for three-phase AC motor

200/208V	HP	10
220/230V	HP	15
460/480V	HP	30
575/600V	HP	30

General USE

Contactor

AC current	A	55
------------	---	----

Short-circuit protection fuse, 600V

High fault

Short circuit current	kA	100
Fuse rating	A	100
Fuse class		J

Standard fault

Short circuit current	kA	5
Fuse rating	A	150

Ambient conditions

Temperature

Operating temperature

min	°C	-50
max	°C	70

Storage temperature

min	°C	-60
max	°C	80

Max altitude

m	3000
---	------

Resistance & Protection

Pollution degree

3

Dimensions

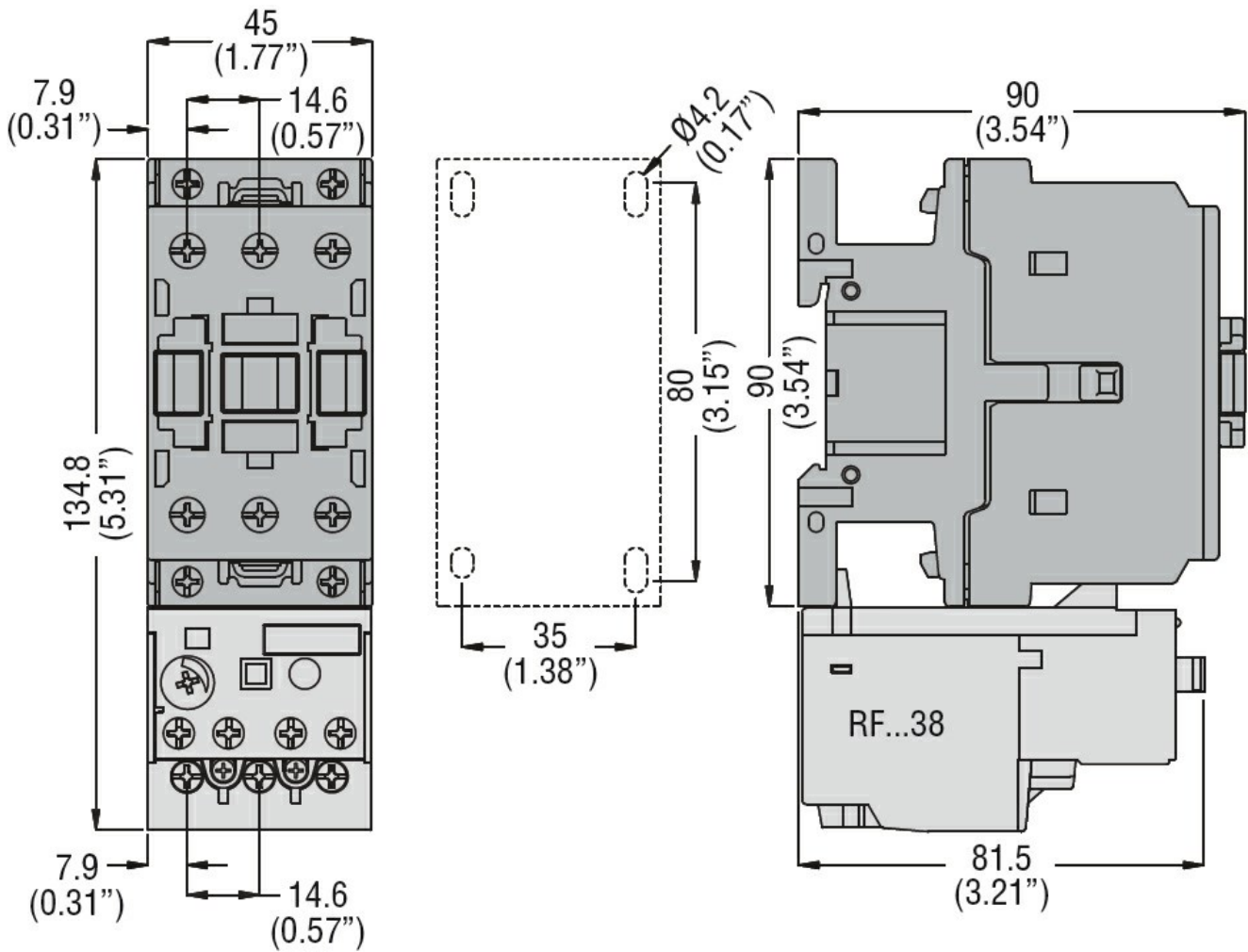

Wiring diagrams

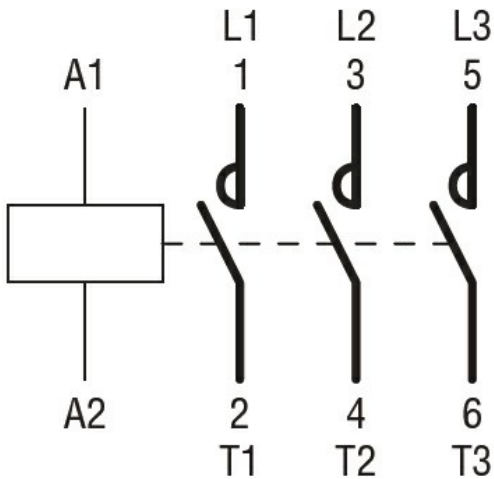

Certifications and compliance

Compliance

CSA C22.2 n° 60947-1

CSA C22.2 n° 60947-4-1

IEC/EN/BS 60947-1

IEC/EN/BS 60947-4-1

UL 60947-1

UL 60947-4-1

Certificates

CCC

cULus

EAC

ETIM classification

ETIM 8.0

EC000066 -
Power contactor,
AC switching