



YG2A15-150C1BN2A15

Industrial Ethernet cables and fieldbus cables

PLUG CONNECTORS AND CABLES

SICK
Sensor Intelligence.



Illustration may differ

Ordering information

Type	Part no.
YG2A15-150C1BN2A15	2115285

Other models and accessories → www.sick.com/Industrial_Ethernet_cables_and_fieldbus_cables



Detailed technical data

Technical specifications

Accessory group	Plug connectors and cables				
Accessory family	Connection cables				
Connection type head A	Female connector, M12, 5-pin, angled				
Connection type head B	Male connector, M12, 5-pin, angled				
Connector material	TPU				
Connector color	Black				
Locking nut material	Zinc die-cast, nickel-plated				
Tightening torque	0.6 Nm				
Width across flats	13				
Cable	15 m, 5-wire				
Jacket color	Violet				
Cable diameter	6.9 mm				
Conductor cross section	2 x 0.34 mm ² + 2 x 0.25 mm ² + 1 x 0.34 mm ²				
Shielding	Shielded				
Bending radius	<table border="0"> <tr> <td style="padding-right: 20px;">Flexible use</td> <td>> 10 x cable diameter</td> </tr> <tr> <td>Stationary position</td> <td>> 6 x cable diameter</td> </tr> </table>	Flexible use	> 10 x cable diameter	Stationary position	> 6 x cable diameter
Flexible use	> 10 x cable diameter				
Stationary position	> 6 x cable diameter				
Bending cycles	≤ 1,000,000				
Reference voltage	≤ 60 V AC/DC				
Traversing speed	5 m/s				
Travelling distance	5 m				
Acceleration	≤ 3 m/s ²				
Signal type	CANopen, DeviceNet™				
Note	A-coded				
Authorizations	UL CE				
UL File No.	E335179				
Enclosure rating	IP65 / IP66 / IP67				
Specialty	Flame-resistant, self-extinguishing				

Ambient operating temperature	
Flexible use	+30 °C ... +70 °C
Stationary position	-40 °C ... +80 °C
Head	-25 °C ... +85 °C
Contamination rating	3
Insulation resistance	> 100 MΩ
Overvoltage category	III
Specific insulation resistance	< 30 mΩ
Thermal resistance, piping	Flame retardant according to UL 1581 Section 1060 (FT1), Section 1061 (cable flame), IEC 60332-1-2

Classifications

ECLASS 5.0	19030312
ECLASS 5.1.4	19030312
ECLASS 6.0	27060304
ECLASS 6.2	27060304
ECLASS 7.0	27060304
ECLASS 8.0	27060304
ECLASS 8.1	27060304
ECLASS 9.0	27060304
ECLASS 10.0	27060304
ECLASS 11.0	27060304
ECLASS 12.0	27060304
ETIM 5.0	EC000830
ETIM 6.0	EC000830
ETIM 7.0	EC003249
ETIM 8.0	EC003249
UNSPSC 16.0901	26121604

Dimensional drawing (Dimensions in mm (inch))

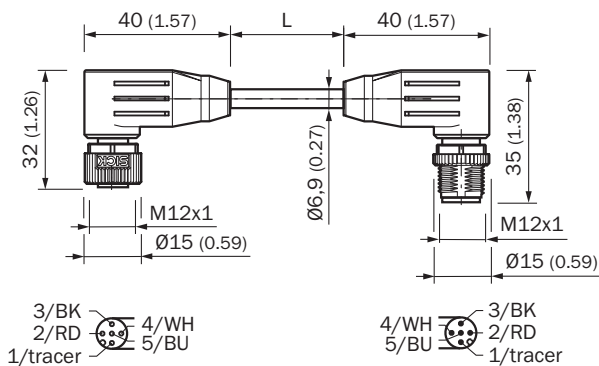

SICK AT A GLANCE

SICK is one of the leading manufacturers of intelligent sensors and sensor solutions for industrial applications. A unique range of products and services creates the perfect basis for controlling processes securely and efficiently, protecting individuals from accidents and preventing damage to the environment.

We have extensive experience in a wide range of industries and understand their processes and requirements. With intelligent sensors, we can deliver exactly what our customers need. In application centers in Europe, Asia and North America, system solutions are tested and optimized in accordance with customer specifications. All this makes us a reliable supplier and development partner.

Comprehensive services complete our offering: SICK LifeTime Services provide support throughout the machine life cycle and ensure safety and productivity.

For us, that is “Sensor Intelligence.”

WORLDWIDE PRESENCE:

Contacts and other locations –www.sick.com