



Product designation	Miniature circuit breaker (MCB)
Product type designation	P1 MB
Number of poles	1P
Number of DIN modules	1
Compliance	IEC / UL489

Electrical features

Rated insulation voltage U_i IEC/EN	V	440
Rated impulse withstand voltage U_{imp}	kV	4
Rated operational voltage AC (IEC)	VAC	230/400
Rated operational voltage AC (UL)	V	277
Rated operational voltage DC	VDC	60
Rated frequency	Hz	50/60
Rated current (I_n)	A	4
Tripping curve		D
Short circuit rating (IEC)	kA	10
Short circuit rating (UL)	kA	10
Electrical life	cycles	10000
Power dissipation per pole max	W	2.16

Ambient conditions

Operating temperature	min	°C	-40
	max	°C	+70
Storage temperature	min	°C	-40
	max	°C	+80
Max altitude		m	2000

Mechanical features

Operating position	normal			
			Vertical plan	
Fixing			35mm DIN rail	
Tightening torque for terminals	min	Nm	1.8	
	max	Nm	2	
	min	lbin	16	
	max	lbin	17.7	
Terminals tool			Pz 2	
Conductor section	IEC	min	mm ²	1
		max	mm ²	35
	AWG/Kcmil	min		14
		max		6
			cycles	20000

Weight	g	133
Frontal IP degree		IP20
Pollution degree		2

Dimensions

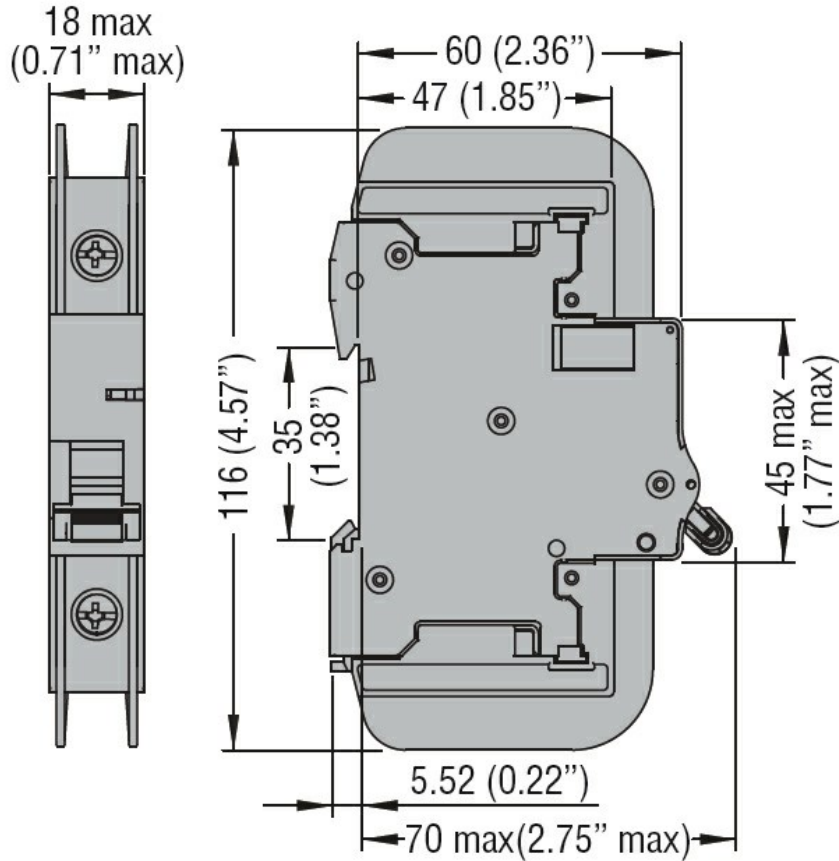

Wiring diagrams



Certifications and compliance

Compliance	IEC/EN 60947-2
	UL489

Certifications	cULus
	EAC

ETIM classification

ETIM 8.0	EC000042 - Miniature circuit breaker (MCB)
----------	--