



Product designation	Power contactor		
Product type designation	B250		
Contact characteristics			
Number of poles	Nr.	3	
Rated insulation voltage U_i IEC/EN	V	1000	
Rated impulse withstand voltage U_{imp}	kV	8	
Operational frequency	min	Hz	25
	max	Hz	400
IEC Conventional free air thermal current I_{th}	A	350	
Operational current I_e	AC-1 ($\leq 40^\circ\text{C}$)	A	350
	AC-1 ($\leq 55^\circ\text{C}$)	A	300
	AC-1 ($\leq 70^\circ\text{C}$)	A	250
	AC-3 ($\leq 440\text{V} \leq 55^\circ\text{C}$)	A	265
	AC-4 (400V)	A	115
Rated operational power AC-3 ($T \leq 55^\circ\text{C}$)	230V	kW	83
	400V	kW	140
	415V	kW	155
	440V	kW	164
	500V	kW	176
	690V	kW	212
	1000V	kW	156
Rated operational power AC-1 ($T \leq 40^\circ\text{C}$)	230V	kW	124
	400V	kW	214
	500V	kW	282
	690V	kW	380
IEC max current I_e in DC1 with $L/R \leq 1\text{ms}$ with 1 poles in series	75V	A	350
	110V	A	160
	220V	A	--
	330V	A	--
	460V	A	--
IEC max current I_e in DC1 with $L/R \leq 1\text{ms}$ with 2 poles in series	75V	A	350
	110V	A	300
	220V	A	250
	330V	A	--
	460V	A	--
IEC max current I_e in DC1 with $L/R \leq 1\text{ms}$ with 3 poles in series	75V	A	350
	110V	A	300
	220V	A	300

	330V	A	250
	460V	A	--
IEC max current I _e in DC1 with L/R ≤ 1ms with 4 poles in series			
	75V	A	350
	110V	A	300
	220V	A	300
	330V	A	300
	460V	A	250
IEC max current I _e in DC3-DC5 with L/R ≤ 15ms with 1 poles in series			
	75V	A	280
	110V	A	150
	220V	A	--
	330V	A	--
	460V	A	--
IEC max current I _e in DC3-DC5 with L/R ≤ 15ms with 2 poles in series			
	75V	A	280
	110V	A	250
	220V	A	200
	330V	A	--
	460V	A	--
IEC max current I _e in DC3-DC5 with L/R ≤ 15ms with 3 poles in series			
	75V	A	280
	110V	A	280
	220V	A	250
	330V	A	200
	460V	A	--
IEC max current I _e in DC3-DC5 with L/R ≤ 15ms with 4 poles in series			
	75V	A	280
	110V	A	280
	220V	A	280
	330V	A	200
	460V	A	200
Short-time allowable current for 10s (IEC/EN60947-1)		A	2200
Protection fuse			
	gG (IEC)	A	400
	aM (IEC)	A	250
Making capacity (RMS value)		A	2750
Breaking capacity at voltage			
	440V	A	2500
	500V	A	2250
	690V	A	2200
Resistance per pole (average value)		mΩ	0.2
Power dissipation per pole (average value)			
	I _{th}	W	24.5
	AC-3	W	12.5
Tightening torque for terminals			
	min	Nm	35
	max	Nm	35
	min	I _{bin}	25.8
	max	I _{bin}	25.8
Tightening torque for coil terminal			
	min	Nm	1
	max	Nm	1

	min	I _{bin}	0.74
	max	I _{bin}	0.74
Max number of wires simultaneously connectable		Nr.	2
Conductor section			
		AWG/Kcmil	
	max		500 kcmil
Power terminal protection according to IEC/EN 60529			IP00
Mechanical features			
Operating position		normal allowable	Vertical plan ±30°
Fixing			Screw
Weight		g	9550
Conductor section			
		AWG/kcmil conductor section	
	max		500 kcmil
Operations			
Mechanical life		cycles	10000000
Electrical life		cycles	1000000
Safety related data			
Performance level B10d according to EN/ISO 13489-1		rated load mechanical load	cycles 1000000 cycles 10000000
Mirror contacts according to IEC/EN 60947-4-1			yes
EMC compatibility			yes
AC coil operating			
Rated AC voltage at 50/60Hz, 60Hz	min	V	380
	max	V	415
AC operating voltage			
		of 50/60Hz coil powered at 50Hz	
		pick-up	
	min	%Us	80
	max	%Us	110
		drop-out	
	min	%Us	20
	max	%Us	60
		of 50/60Hz coil powered at 60Hz	
		pick-up	
	min	%Us	80
	max	%Us	110
		drop-out	
	min	%Us	20
	max	%Us	60
		of 60Hz coil powered at 60Hz	
		pick-up	
	min	%Us	80
	max	%Us	110
		drop-out	
	min	%Us	20
	max	%Us	60
AC average coil consumption at 20°C			
		of 50/60Hz coil powered at 50Hz	

	in-rush	VA	300
	holding	VA	10
of 50/60Hz coil powered at 60Hz			
	in-rush	VA	300
	holding	VA	10
Dissipation at holding $\leq 20^{\circ}\text{C}$ 50Hz		W	10
DC coil operating			
DC rated control voltage			
	min	V	380
	max	V	415
DC operating voltage			
pick-up			
	min	%Us	80
	max	%Us	110
drop-out			
	min	%Us	20
	max	%Us	60
Average coil consumption $\leq 20^{\circ}\text{C}$			
	in-rush	W	300
	holding	W	10
Max cycles frequency			
Mechanical operation		cycles/h	2400
Operating times			
Average time for Us control			
in AC			
Closing NO			
	min	ms	80
	max	ms	120
Opening NO			
	min	ms	30
	max	ms	75
in DC			
Closing NO			
	min	ms	80
	max	ms	120
Opening NO			
	min	ms	30
	max	ms	75
UL technical data			
Full-load current (FLA) for three-phase AC motor			
	at 480V	A	240
	at 600V	A	242
Yielded mechanical performance			
for three-phase AC motor			
	200/208V	HP	75
	220/230V	HP	100
	575/600V	HP	250
General USE			
Contactor			
	AC current	A	350
Short-circuit protection fuse, 600V			
Standard fault			
	Short circuit current	kA	18
	Fuse rating	A	800

		Fuse class	L
Ambient conditions			
Temperature			
Operating temperature		min	°C -50
		max	°C 70
<hr/>			
Storage temperature		min	°C -60
		max	°C 80
<hr/>			
Max altitude		m	3000

Resistance & Protection

Pollution degree	3
------------------	---

Dimensions

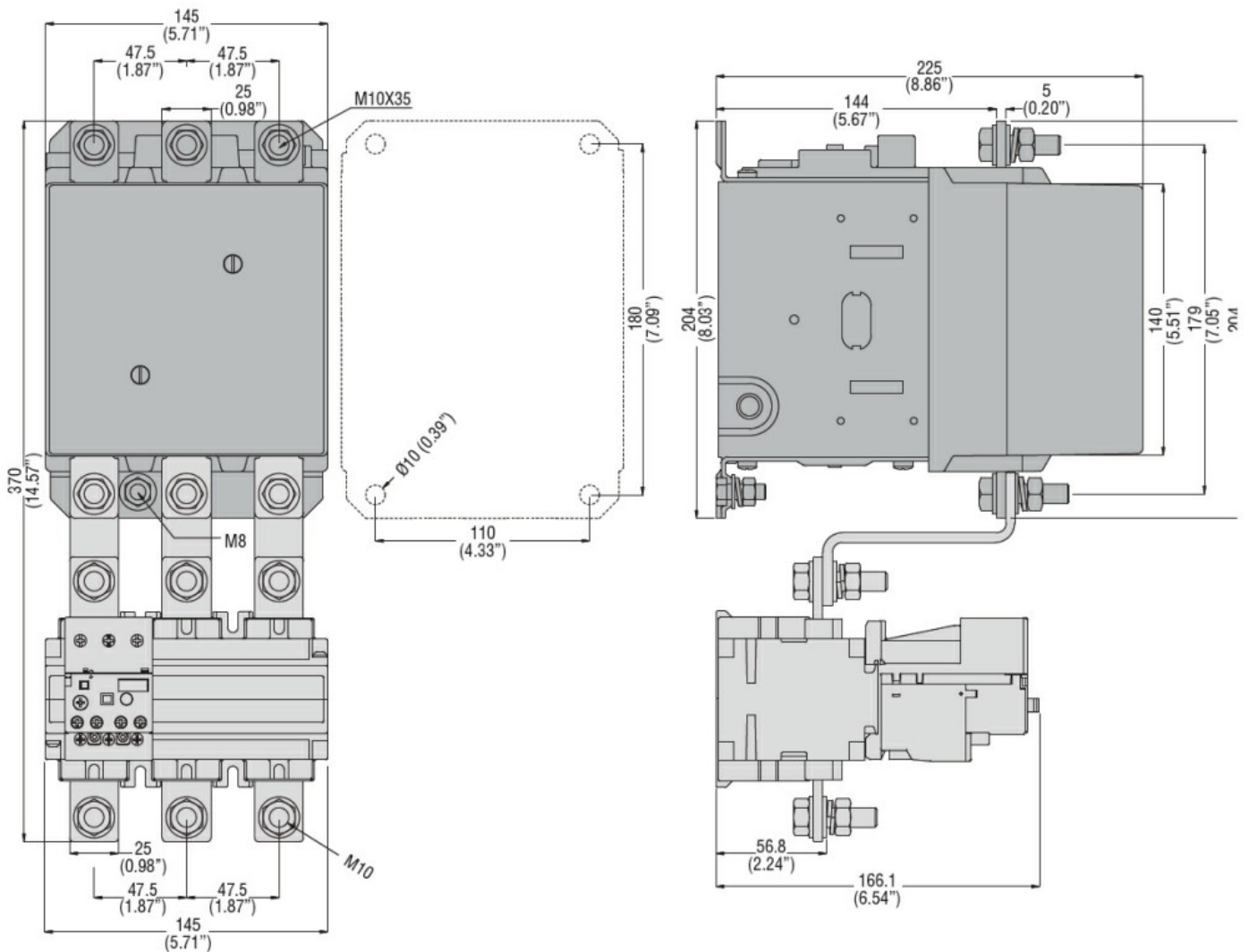

Wiring diagrams

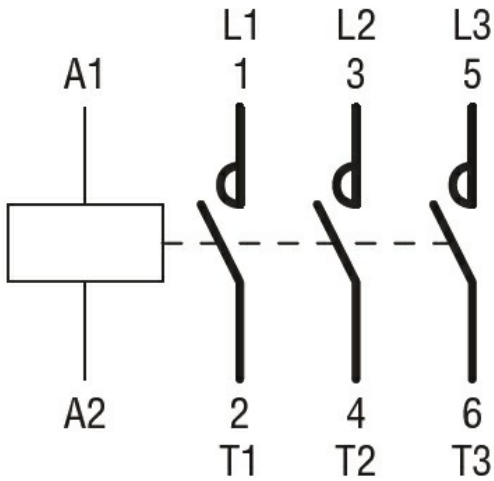

Certifications and compliance

Compliance

CSA C22.2 n° 60947-1

CSA C22.2 n° 60947-4-1

IEC/EN 60947-1

IEC/EN 60947-4-1

UL 60947-1

UL 60947-4-1

Certificates

CCC

cULus

EAC

ETIM classification

ETIM 8.0

EC000066 -
Power contactor,
AC switching