



Product designation				Enclosed switch disconnectors
Product type designation				GLZM
Number of poles	Nr.			4
Operating voltage type				AC
<b>Contact characteristics</b>				
IEC Conventional free air thermal current I <sub>th</sub>	A			250
Rated insulation voltage U <sub>i</sub> IEC/EN	V			1000
Rated impulse withstand voltage U <sub>imp</sub>	kV			12
Operating current I <sub>e</sub>				
AC21A	400V	A	250	
	500V	A	250	
	690V	A	250	
AC22A	400V	A	250	
	500V	A	250	
	690V	A	250	
AC23A	400V	A	250	
	500V	A	250	
	690V	A	250	
Power dissipation per pole max	W			6.5
Rated operational power AC23A	400V	kW	140	
	690V	kW	250	
Conditional short-circuit current (rms)	kA			100
Short-circuit protection with fuse	Class/A			gG/250
Making capacity AC23A 400V	A			2500
Breaking capacity AC23A 400V	A			2000
Mechanical life	cycles			10000
<b>Mechanical features</b>				
Operating position	normal allowable			Vertical plan Any
Terminals	type			M8 x 25
Tightening torque for terminals	min	Nm	15	
	max	Nm	22	
	min	lbin	132	
	max	lbin	194	
Conductor section	IEC min	mm <sup>2</sup>	70	
	IEC max	mm <sup>2</sup>	185	

AWG/kcmil min	00
AWG/kcmil max	400

**Ambient conditions**

Operating temperature

min	°C	-25
max	°C	+55

Storage temperature

min	°C	-40
max	°C	+70

Max altitude

m	3000
---	------

**Resistance & Protection**

Frontal IP degree

IP65

IP degree of protection

IP65

Pollution degree

3

**Dimensions**

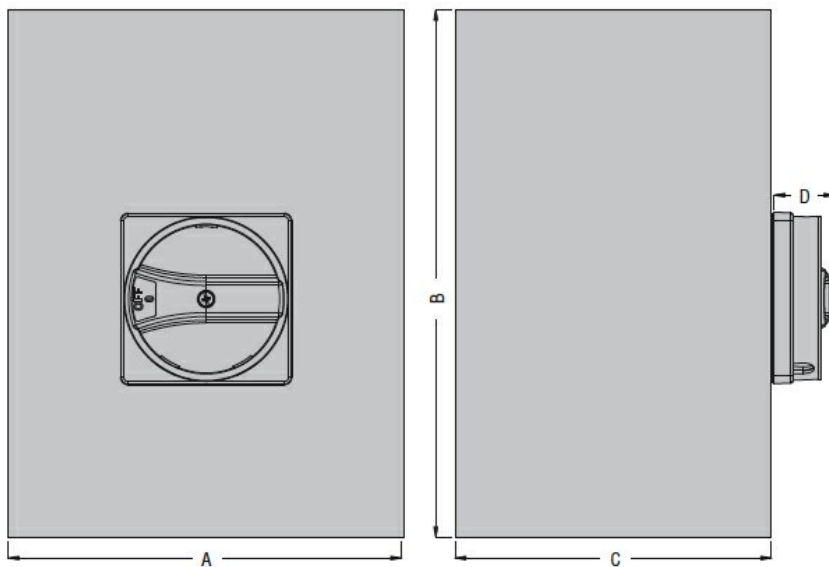

Type	A	B	C	D
GLZM0160...GLZM0315...	300 (11.81")	400 (15.75")	250 (9.84")	45,7 (1.80")

**Wiring diagrams**

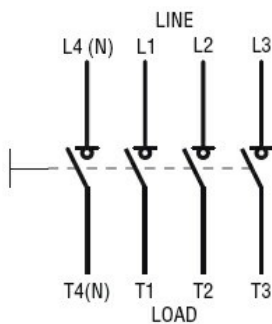

**Certifications and compliance**

Compliance

IEC/EN 60947-1

IEC/EN 60947-3

**ETIM classification**

ETIM 8.0

EC000216 -  
Switch  
disconnecter