

Part number

# COB 06 CMS



Insulating insert carrier enclosure for mobile mounting, COB panel supports series, side cable entry with cable clamp, for inserts with 44 x 27 mm screw fixing centre distance

## Product description

<b>Product type</b>	Insulating insert carrier enclosure for mobile mounting
<b>Series</b>	COB panel supports
<b>Cable entry</b>	Side cable entry with cable clamp
<b>Specification</b>	For inserts with 44 x 27 mm screw fixing centre distance

## Technical data

<b>IP degree of protection</b>	IP20
--------------------------------	------

## Further technical details

<b>Weight</b>	65,00 g
<b>Operating temperature range (min, max)</b>	-40°C...+125°C

## Material properties

<b>Colour</b>	RAL 7032 grey
<b>RoHs conformity</b>	Compliant with exemption 6(c): copper alloy containing up to 4% lead by weight
<b>China RoHs - EFUP</b>	50
<b>REACH SVHC substances</b>	Yes Lead
<b>SCIP number</b>	B008b8e4-629e-4e70-ab7d-b3b67464925d

## Approvals / Standards

<b>Certifications</b>	DNV, BV
<b>UL</b>	ECBT2
<b>cUL</b>	ECBT8

## General ordering information

<b>EAN13 code</b>	8015747036498
<b>eCl@ss 8.1</b>	27440202
<b>ETIM 7.0</b>	EC000437

## Packaging Information

<b>Packaging length</b>	225,00 mm
<b>Packaging height</b>	120,00 mm
<b>Packaging width</b>	135,00 mm
<b>Packaging weight</b>	0,65 kg
<b>Packaging volume</b>	3,65 dm <sup>3</sup>
<b>Packaging description</b>	Carton box
<b>Packaging quantity</b>	10 Pcs
<b>Packaging EAN code</b>	8015747036504
<b>Sub-packaging weight</b>	0,07 kg
<b>Sub-packaging description</b>	Carton tray
<b>Sub-packaging quantity</b>	1 Pcs
<b>Sub-packaging EAN barcode</b>	8015747036511

Part number

# COB 06 CMS



Catalogue drawings

**COB..CMS**

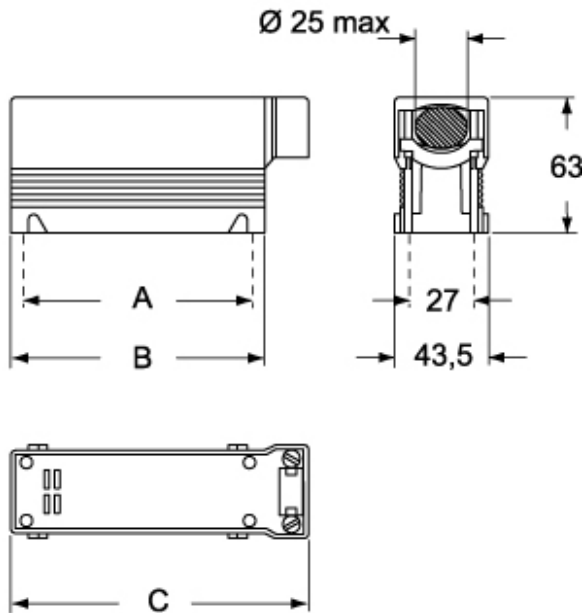

## Notes

Dimensions shown in mm are not binding and may be changed without notice.