



MPA-287THTPO

MPA

POSITION SENSORS

SICK
Sensor Intelligence.



Ordering information

| Type | Part no. |
|--------------|----------|
| MPA-287THTPO | 1059452 |

Other models and accessories → www.sick.com/MPA



Detailed technical data

Features

| | |
|------------------------------------|---|
| Cylinder type | Universal |
| Cylinder types with adapter | Round body cylinder Tie rod cylinder T-slot cylinders Festo cylinders DSBC SMC cylinders CP96 |
| Measuring range | 287 mm ¹⁾ |
| Housing length | 289 mm |
| Output function | Analog, IO-Link |
| Electrical wiring | DC 4-wire |
| Analog output (voltage) | 0 V ... 10 V |
| Analog output (current) | 4 mA ... 20 mA ²⁾ |
| Enclosure rating | IP65, IP67, IP68 ³⁾ |
| IO-Link functions | Standard functions |
| Adjustment | |
| Teach-in control panel | Teaching in the measuring range Selecting the current/voltage output or IO-Link Resetting the measuring range to factory settings |
| IO-Link | Teaching in the measuring range Resetting the measuring range |

¹⁾ ± 1 mm.

²⁾ Default setting: Current output active.

³⁾ According to EN 60529.

Mechanics/electronics

| | |
|--|--|
| Supply voltage | 15 V DC ... 30 V DC |
| Power consumption | 35 mA, without load |
| Max. load resistance | ≤ 500 Ω Power Output, at 24 V |
| Min. load resistance | ≥ 2 kΩ ¹⁾ |
| Protection class | III |
| Required magnetic field sensitivity, typ. | 2 mT ... 15 mT |
| Resolution, typ. | 0.03 % FSR (max. ≥ 0.06 mm) ^{2) 3)} |
| Linearity error, typ. | 0.5 mm ⁴⁾ |
| Repeat accuracy, typ. | 0.06 % FSR (≥ 0.1 mm) ⁵⁾ |
| Sampling rate, typ. | 1.15 ms ⁶⁾ |
| Reverse polarity protection | Yes |
| Short-circuit protection | Yes |
| Status indicator LED | Yes |
| Teach-in | Yes |
| Ambient operating temperature | -20 °C ... +70 °C |
| Shock and vibration resistance | 30 g, 11 ms/10 Hz ... 55 Hz, 1 mm |
| EMC | According to EN 60947-5-2 ⁷⁾ |
| Connection type | Cable with M8 male connector, 4-pin, 0.3 m |
| Connection type Detail | |
| Deep-freeze property | Do not bend below 0 °C |
| Conductor cross section | 0.08 mm ² |
| Cable diameter | Ø 2.6 mm |
| Bending radius | With fixed installation > 5 x cable diameter For flexible use > 10 x cable diameter |
| Cable outlet | Axial |
| Material | |
| Housing | Metal, Aluminum, plastic |
| Cable | PUR |
| UL File No. | NRKH.E181493 & NRKH7.E181493 |

¹⁾ Voltage output.

²⁾ FSR: Full Scale Range; max. measuring range.

³⁾ When using IO-Link, the resolution is 0.25 mm.

⁴⁾ At 25 °C, linearity error (maximum deviation) depending on response curve and minimal deviation function.

⁵⁾ At 25 °C, repeatability magnet movement in one direction.

⁶⁾ Only in standard mode, not in IO-Link mode.

⁷⁾ The analog measured value can deviate under transient conditions.

Safety-related parameters

| | |
|-------------------------------------|-----------|
| MTTF_D | 172 years |
| DC_{avg} | 0 % |
| T_M (mission time) | 20 years |

Communication interface

| | |
|---------------------------------------|--|
| Communication interface | IO-Link V1.0.1 |
| Communication Interface detail | COM2 |
| Cycle time | 2.3 ms |
| Process data length | 16 Bit |
| Process data structure | Bit 0 ... 3 = reserved Bit 4 ... 5 = position (after decimal point) Bit 6 ... 15 = position (before decimal point) |

Classifications

| | |
|-----------------------|----------|
| ECLASS 5.0 | 27270104 |
| ECLASS 5.1.4 | 27270104 |
| ECLASS 6.0 | 27270104 |
| ECLASS 6.2 | 27270104 |
| ECLASS 7.0 | 27270104 |
| ECLASS 8.0 | 27270104 |
| ECLASS 8.1 | 27270104 |
| ECLASS 9.0 | 27270104 |
| ECLASS 10.0 | 27270104 |
| ECLASS 11.0 | 27270104 |
| ECLASS 12.0 | 27274301 |
| ETIM 5.0 | EC002544 |
| ETIM 6.0 | EC002544 |
| ETIM 7.0 | EC002544 |
| ETIM 8.0 | EC002544 |
| UNSPSC 16.0901 | 39122230 |

Connection diagram

Cd-230

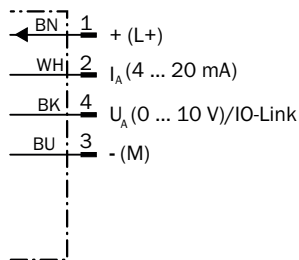

Dimensional drawing (Dimensions in mm (inch))

Cable with M8 male connector, 4-pin

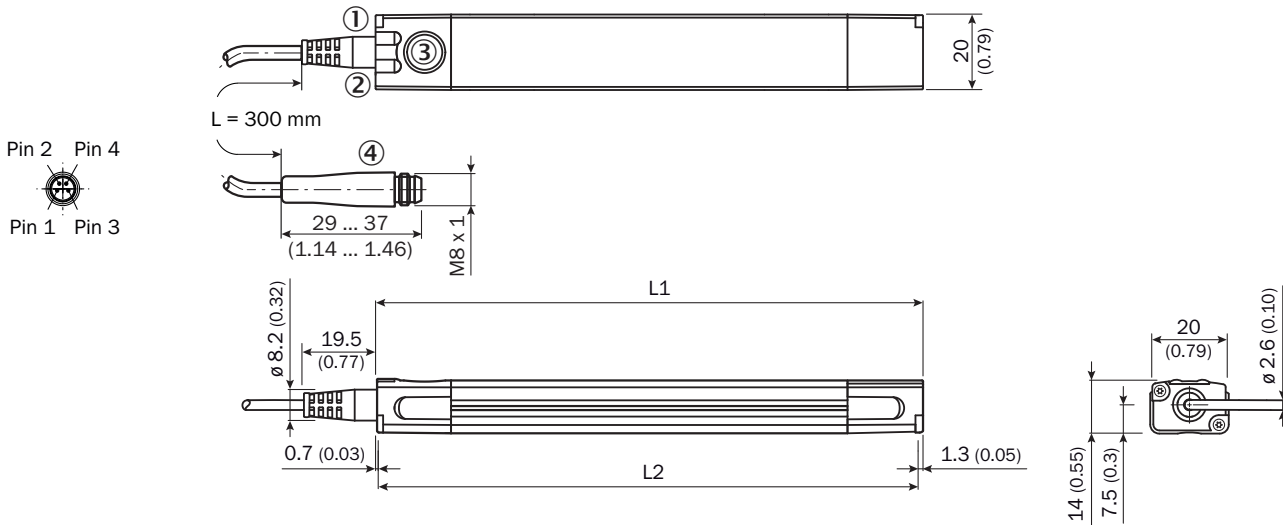

| | Total length (L1) mm | Measuring range (L2) mm | | Total length (L1) mm | Measuring range (L2) mm |
|----------------|----------------------|-------------------------|-----------------|----------------------|-------------------------|
| MPA-107 | 109 | 107 | MPA-575 | 577 | 575 |
| MPA-143 | 145 | 143 | MPA-611 | 613 | 611 |
| MPA-179 | 181 | 179 | MPA-647 | 649 | 647 |
| MPA-215 | 217 | 215 | MPA-683 | 685 | 683 |
| MPA-251 | 253 | 251 | MPA-719 | 721 | 719 |
| MPA-287 | 289 | 287 | MPA-755 | 757 | 755 |
| MPA-323 | 325 | 323 | MPA-791 | 793 | 791 |
| MPA-359 | 361 | 359 | MPA-827 | 829 | 827 |
| MPA-395 | 397 | 395 | MPA-863 | 865 | 863 |
| MPA-431 | 433 | 431 | MPA-899 | 901 | 899 |
| MPA-467 | 469 | 467 | MPA-935 | 937 | 935 |
| MPA-503 | 505 | 503 | MPA-971 | 973 | 971 |
| MPA-539 | 541 | 539 | MPA-1007 | 1,009 | 1,007 |





- ① Function signal indicator 1
- ② Function signal indicator 2
- ③ Teach-Pad
- ④ Connection

Recommended accessories

Other models and accessories → www.sick.com/MPA

| | Brief description | Type | Part no. |
|---|--|--------|----------|
| Magnets | | | |
|  | Magnet with mounting hole for M3 countersunk screw, ø 15.2 mm, height 6 mm | Magnet | 5327349 |

| | Brief description | Type | Part no. |
|---|---|--------------------|----------|
| Brackets for cylinder sensors | | | |
|  | Sensor adapter DSBC-32, Stainless steel V2A | BEF-KHZPF032MPA | 2086744 |
| | Sensor adapter DSBC-40, Stainless steel V2A | BEF-KHZPF040MPA | 2086745 |
| | Sensor adapter DSBC-50, Stainless steel V2A | BEF-KHZPF050MPA | 2086746 |
| | Sensor adapter DSBC-63, Stainless steel V2A | BEF-KHZPF063MPA | 2086747 |
| | Sensor adapter DSBC-80, Stainless steel V2A | BEF-KHZPF080MPA | 2086748 |
| | Sensor adapter DSBC-100, Stainless steel V2A | BEF-KHZPF100MPA | 2086749 |
| | Sensor adapter DSBC-125, Stainless steel V2A | BEF-KHZPF125MPA | 2086750 |
|  | For tie-rod cylinder (diameter tie-rod max. 18 mm), Aluminum alloy (adapter), Stainless steel V2A (mounting-/fixing screw) | BEF-KHZPZ1MPA | 2065578 |
| | For round body cylinders with diameter up to 85 mm, Stainless steel V2A | BEF-KHZR085MPA | 2066626 |
|  | For round body cylinders with diameter up to 135 mm, Stainless steel V2A | BEF-KHZR135MPA | 2066627 |
| | For round body cylinders with diameter up to 210 mm, Stainless steel V2A | BEF-KHZR210MPA | 2066628 |
|  | Sensor adapter CP96-63, Stainless steel V2A | BEF-KHZTS063MPA | 2086756 |
| | Sensor adapter CP96-80, Stainless steel V2A | BEF-KHZTS080MPA | 2086757 |
| | Sensor adapter CP96-100, Stainless steel V2A | BEF-KHZTS100MPA | 2086758 |
| | Sensor adapter CP96-125, Stainless steel V2A | BEF-KHZTS125MPA | 2086759 |
|  | For T-slot cylinders, Stainless steel V2A (bracket/mounting screw), Brass (fixing screw/sliding nut) | BEF-KHZT01MPA | 2065575 |
| Mounting brackets and plates | | | |
|  | Bracket for low mounting, Stainless steel V2A (bracket/mounting screw), Brass (fixing screw) | BEF-WNL01MPA | 2065973 |
|  | Bracket for lateral mounting, Stainless steel V2A (bracket/mounting screw), Brass (fixing screw) | BEF-WNZ01MPA | 2065577 |
| Other mounting accessories | | | |
|  | 10 pieces, Label Holder, 2.5 mm to 3.5 mm, 10 pcs., TPU | LABEL HOLDER | 2086019 |
| Plug connectors and cables | | | |
|  | <ul style="list-style-type: none"> • Connection type head A: Female connector, M8, 4-pin, straight, A-coded • Connection type head B: Flying leads • Signal type: Sensor/actuator cable • Cable: 2 m, 4-wire, PUR, halogen-free • Description: Sensor/actuator cable, unshielded • Application: Zones with oils and lubricants, Drag chain operation, Robot | YF8U14-020UA3XLEAX | 2094791 |
| | <ul style="list-style-type: none"> • Connection type head A: Female connector, M8, 4-pin, straight, A-coded • Connection type head B: Flying leads • Signal type: Sensor/actuator cable • Cable: 5 m, 4-wire, PUR, halogen-free • Description: Sensor/actuator cable, unshielded • Application: Zones with oils and lubricants, Drag chain operation, Robot | YF8U14-050UA3XLEAX | 2094792 |

| | Brief description | Type | Part no. |
|---|---|--------------------|----------|
|  | <ul style="list-style-type: none"> • Connection type head A: Female connector, M8, 4-pin, angled, A-coded • Connection type head B: Flying leads • Signal type: Sensor/actuator cable • Cable: 2 m, 4-wire, PUR, halogen-free • Description: Sensor/actuator cable, unshielded • Application: Zones with oils and lubricants, Drag chain operation, Robot | YG8U14-020UA3XLEAX | 2095589 |
| | <ul style="list-style-type: none"> • Connection type head A: Female connector, M8, 4-pin, angled, A-coded • Connection type head B: Flying leads • Signal type: Sensor/actuator cable • Cable: 5 m, 4-wire, PUR, halogen-free • Description: Sensor/actuator cable, unshielded • Application: Zones with oils and lubricants, Drag chain operation, Robot | YG8U14-050UA3XLEAX | 2095590 |
|  | <ul style="list-style-type: none"> • Connection type head A: Female connector, M8, 4-pin, straight • Description: Unshielded • Connection systems: Screw-type terminals • Permitted cross-section: 0.14 mm² ... 0.5 mm² | DOS-0804-G | 6009974 |
|  | <ul style="list-style-type: none"> • Connection type head A: Female connector, M8, 4-pin, angled • Description: Unshielded • Connection systems: Solder connection • Permitted cross-section: ≤ 0.25 mm² | DOS-0804-W | 6009975 |
|  | <ul style="list-style-type: none"> • Connection type head A: Male connector, M8, 4-pin, straight • Description: Unshielded • Connection systems: Screw-type terminals • Permitted cross-section: 0.14 mm² ... 0.5 mm² | STE-0804-G | 6037323 |

Recommended services

Additional services → www.sick.com/MPA

| | Type | Part no. |
|--|------------------------|------------|
| Function Block Factory | | |
| <ul style="list-style-type: none"> • Description: The Function Block Factory supports common programmable logic controllers (PLCs) from various manufacturers, such as Siemens, Beckhoff, Rockwell Automation and B&R. More information on the FBF can be found <a _blank"="" href="https://fbf.cloud.sick.com target=">here. • Note: You can configure your function block at <a _blank"="" href="https://fbf.cloud.sick.com target=">Function Block Factory. As a login please use your SICK ID. | Function Block Factory | On request |

SICK AT A GLANCE

SICK is one of the leading manufacturers of intelligent sensors and sensor solutions for industrial applications. A unique range of products and services creates the perfect basis for controlling processes securely and efficiently, protecting individuals from accidents and preventing damage to the environment.

We have extensive experience in a wide range of industries and understand their processes and requirements. With intelligent sensors, we can deliver exactly what our customers need. In application centers in Europe, Asia and North America, system solutions are tested and optimized in accordance with customer specifications. All this makes us a reliable supplier and development partner.

Comprehensive services complete our offering: SICK LifeTime Services provide support throughout the machine life cycle and ensure safety and productivity.

For us, that is “Sensor Intelligence.”

WORLDWIDE PRESENCE:

Contacts and other locations –www.sick.com