



# WTB8-N2131

W8

MINIATURE PHOTOELECTRIC SENSORS

**SICK**  
Sensor Intelligence.



Illustration may differ



### Ordering information

Type	Part no.
WTB8-N2131	6033206

**Included in delivery:** BEF-W100-A (1)

Other models and accessories → [www.sick.com/W8](http://www.sick.com/W8)

### Detailed technical data

#### Features

<b>Functional principle</b>	Photoelectric proximity sensor
<b>Functional principle detail</b>	Background suppression
<b>Dimensions (W x H x D)</b>	11 mm x 31 mm x 20 mm
<b>Housing design (light emission)</b>	Rectangular
<b>Sensing range max.</b>	30 mm ... 300 mm <sup>1)</sup>
<b>Sensing range</b>	40 mm ... 300 mm <sup>1)</sup>
<b>Type of light</b>	Visible red light
<b>Light source</b>	LED <sup>2)</sup>
<b>Light spot size (distance)</b>	Ø 20 mm (300 mm)
<b>Wave length</b>	650 nm
<b>Adjustment</b>	Potentiometer, 4 turns

<sup>1)</sup> Object with 90% remission (based on standard white, DIN 5033).

<sup>2)</sup> Average service life: 100,000 h at T<sub>U</sub> = +25 °C.

#### Mechanics/electronics

<b>Supply voltage U<sub>B</sub></b>	10 V DC ... 30 V DC <sup>1)</sup>
<b>Ripple</b>	± 10 % <sup>2)</sup>

<sup>1)</sup> Limit values when operated in short-circuit protected network: max. 8 A.

<sup>2)</sup> May not exceed or fall below U<sub>v</sub> tolerances.

<sup>3)</sup> Without load.

<sup>4)</sup> Signal transit time with resistive load.

<sup>5)</sup> With light/dark ratio 1:1.

<sup>6)</sup> A = V<sub>S</sub> connections reverse-polarity protected.

<sup>7)</sup> B = inputs and output reverse-polarity protected.

<sup>8)</sup> D = outputs overcurrent and short-circuit protected.

<b>Current consumption</b>	30 mA <sup>3)</sup>
<b>Switching output</b>	NPN
<b>Switching mode</b>	Light/dark switching
<b>Switching mode selector</b>	Selectable via light/dark rotary switch
<b>Signal voltage NPN HIGH/LOW</b>	Approx. $V_S / < 1.8 \text{ V}$
<b>Output current <math>I_{\text{max}}</math></b>	$\leq 100 \text{ mA}$
<b>Response time</b>	$\leq 0.5 \text{ ms}$ <sup>4)</sup>
<b>Switching frequency</b>	1,000 Hz <sup>5)</sup>
<b>Connection type</b>	Connector M8, 3-pin
<b>Circuit protection</b>	A <sup>6)</sup> B <sup>7)</sup> D <sup>8)</sup>
<b>Weight</b>	10 g
<b>Housing material</b>	Plastic, ABS
<b>Optics material</b>	Plastic, PMMA
<b>Enclosure rating</b>	IP67
<b>Items supplied</b>	Stainless steel mounting bracket (1.4301/304) BEF-W100-A
<b>Ambient operating temperature</b>	-25 °C ... +55 °C
<b>Ambient temperature, storage</b>	-40 °C ... +70 °C

<sup>1)</sup> Limit values when operated in short-circuit protected network: max. 8 A.

<sup>2)</sup> May not exceed or fall below  $U_V$  tolerances.

<sup>3)</sup> Without load.

<sup>4)</sup> Signal transit time with resistive load.

<sup>5)</sup> With light/dark ratio 1:1.

<sup>6)</sup> A =  $V_S$  connections reverse-polarity protected.

<sup>7)</sup> B = inputs and output reverse-polarity protected.

<sup>8)</sup> D = outputs overcurrent and short-circuit protected.

### Safety-related parameters

<b>MTTF<sub>D</sub></b>	1,568 years
<b>DC<sub>avg</sub></b>	0 %

### Classifications

<b>ECLASS 5.0</b>	27270904
<b>ECLASS 5.1.4</b>	27270904
<b>ECLASS 6.0</b>	27270904
<b>ECLASS 6.2</b>	27270904
<b>ECLASS 7.0</b>	27270904
<b>ECLASS 8.0</b>	27270904
<b>ECLASS 8.1</b>	27270904
<b>ECLASS 9.0</b>	27270904
<b>ECLASS 10.0</b>	27270904
<b>ECLASS 11.0</b>	27270904
<b>ECLASS 12.0</b>	27270903

<b>ETIM 5.0</b>	EC002719
<b>ETIM 6.0</b>	EC002719
<b>ETIM 7.0</b>	EC002719
<b>ETIM 8.0</b>	EC002719
<b>UNSPSC 16.0901</b>	39121528

### Dimensional drawing (Dimensions in mm (inch))

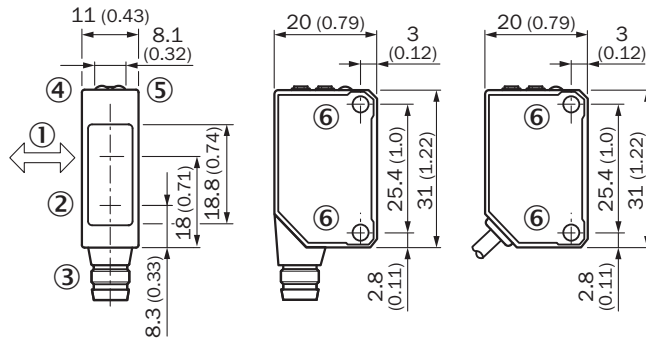

- ① Standard direction
- ② Center of optical axis, sender
- ③ Connection
- ④ Orange LED indicator : switching output active
- ⑤ LED indicator green: stability indicator
- ⑥ Threaded mounting hole M3

### Adjustments

WTB8

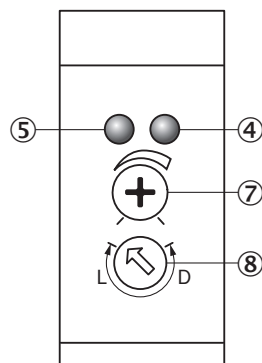

- ④ Orange LED indicator : switching output active
- ⑤ LED indicator green: stability indicator
- ⑦ Adjustment of sensing range
- ⑧ Light/ dark rotary switch: L = light switching, D = dark switching

Connection type

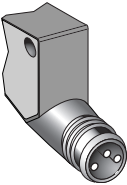

Connection diagram

Cd-045

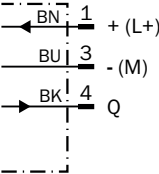

Characteristic curve

WTB8, 300 mm

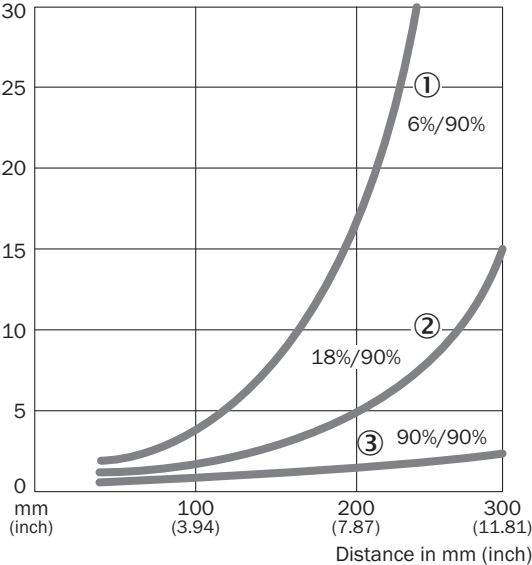

- ① Sensing range on black, 6% remission factor
- ② Sensing range on gray, 18% remission factor
- ③ Sensing range on white, 90% remission factor

### Sensing range diagram

WTB8, 300 mm

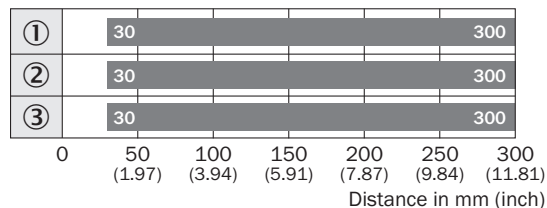



■ Sensing range

- ① Sensing range on black, 6% remission factor
- ② Sensing range on gray, 18% remission factor
- ③ Sensing range on white, 90% remission factor

### Recommended accessories

Other models and accessories → [www.sick.com/W8](http://www.sick.com/W8)

	Brief description	Type	Part no.
Plug connectors and cables			
	<ul style="list-style-type: none"> <li>• <b>Connection type head A:</b> Male connector, M8, 3-pin, straight</li> <li>• <b>Description:</b> Unshielded</li> <li>• <b>Connection systems:</b> Screw-type terminals</li> <li>• <b>Permitted cross-section:</b> 0.14 mm<sup>2</sup> ... 0.5 mm<sup>2</sup></li> </ul>	STE-0803-G	6037322
Others			
	<ul style="list-style-type: none"> <li>• <b>Connection type head A:</b> Female connector, M8, 3-pin, straight, A-coded</li> <li>• <b>Connection type head B:</b> Flying leads</li> <li>• <b>Signal type:</b> Sensor/actuator cable</li> <li>• <b>Cable:</b> 5 m, 3-wire, PVC</li> <li>• <b>Description:</b> Sensor/actuator cable, unshielded</li> <li>• <b>Application:</b> Zones with chemicals</li> </ul>	YF8U13-050VA1XLEAX	2095884

## SICK AT A GLANCE

SICK is one of the leading manufacturers of intelligent sensors and sensor solutions for industrial applications. A unique range of products and services creates the perfect basis for controlling processes securely and efficiently, protecting individuals from accidents and preventing damage to the environment.

We have extensive experience in a wide range of industries and understand their processes and requirements. With intelligent sensors, we can deliver exactly what our customers need. In application centers in Europe, Asia and North America, system solutions are tested and optimized in accordance with customer specifications. All this makes us a reliable supplier and development partner.

Comprehensive services complete our offering: SICK LifeTime Services provide support throughout the machine life cycle and ensure safety and productivity.

For us, that is “Sensor Intelligence.”

## WORLDWIDE PRESENCE:

Contacts and other locations –[www.sick.com](http://www.sick.com)