

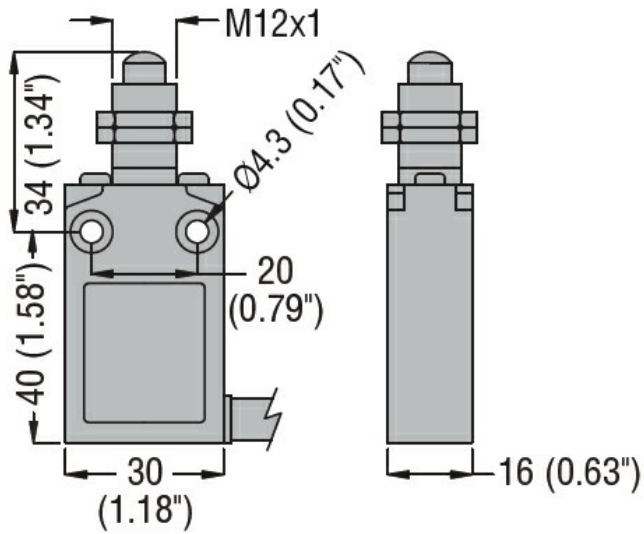

Product designation	Top push rod plunger		
Product type designation	KPA2		
General characteristics			
Material	Housing	Aluminium-zinc alloy	
	Roller	Metal	
Contact characteristics			
Type of contact	1NO+1NC Snap action		
Thermal current I _{th}	A	10	
IEC/EN 60947-5-1 designation	B300 R300		
Rated insulation voltage U _i	V	400	
Rated impulse withstand voltage U _{imp}	kV	4	
Insulation class	I		
IEC Conventional free air thermal current I _{th}	A	10	
Resistance per pole (average value)	mΩ	<25	
Conductivity	10mA 5V		
Mechanical features			
Operating head fixing	Fixed		
Operating torque	N	15	
	lb	3.4	
Tightening torque (Max)	Switch fixing		
	Nm	2.5	
	lbin	22.1	
Weight	g	302	
Operations			
Mechanical life	cycles	>10000000	
Mechanical operation	cycles/h	3600	
Ambient conditions			
Temperature	Operating temperature		
	min	°C	-25
	max	°C	+70
	Storage temperature		
	min	°C	-40
	max	°C	+70
Resistance & Protection			
IP degree	Body housing	IP67	
Pollution degree	3		
Dimensions			



Wiring diagrams

Snap action

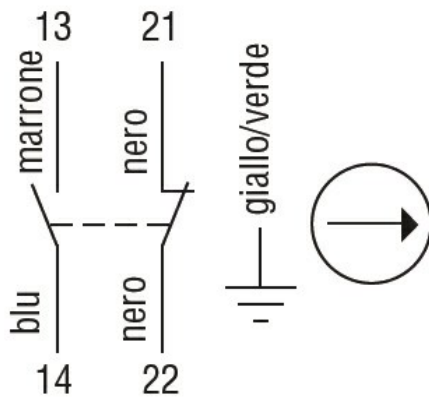

1NO + 1NC

Certifications and compliance

Compliance

CSA C22.2 n° 14.

IEC/EN 60947-1

IEC/EN 60947-5-1

UL508

Certificates

cULus

EAC

ETIM classification

ETIM 8.0

EC000030 - End
switch