

PAR64 64739/4 MFL

PAR64 | Halogen lamps with parabolic reflector PAR64, with pin base



Areas of application

- Events
- Performances
- Stage productions

Product family benefits

- Easy lamp replacement
- Flexible operating position

Product family features

- The parabolic glass reflector and the front lens are fused together
- High luminous intensity
- Available in different beam angles to ensure high flexibility



Product datasheet

Technical data

Electrical data

Nominal voltage	240 V
On-mode power	1035.00 W
Energy consumption in on-mode	1035.0 kWh/1000h

Photometrical data

Color temperature	3200 K
Luminous intensity	125000 cd
Φ_{use} value refers to luminous flux ..	90
Correlated color temperature CCT	3090 K
Useful luminous flux (Φ_{use})	15800 lm
Chromaticity coordinate x	0.430
Chromaticity coordinate y	0.402

Light technical data

Beam spot height	43 m
------------------	------

Dimensions & weight

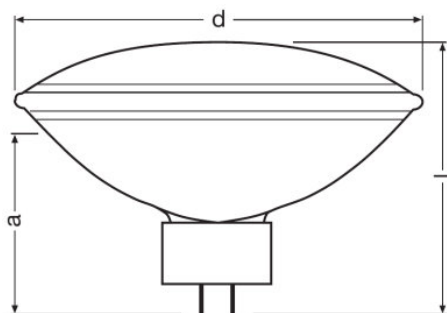

Light center length (LCL)	102.0 mm
Product weight	790.00 g
Length	152.4 mm
Diameter	204.0 mm

Lifespan

Lifespan	300 h
----------	-------

Additional product data

Product datasheet

Base (standard designation)	GX16d
Lighting technology used	HL

Capabilities

Burning position	hs30 ¹⁾
------------------	--------------------

¹⁾ Do not tilt perpendicular to the filament

Certificates & standards

Energy efficiency class	G
-------------------------	---

Country specific categorizations

ANSI code	Other
-----------	-------

Environmental information

Information according Art. 33 of EU Regulation (EC) 1907/2006 (REACH)	
Date of Declaration	08-09-2023
Primary Article Identifier	4062172359252
Candidate List Substance 1	No declarable substances contained
Declaration No. in SCIP database	No declarable substances contained

Product datasheet

Safety advice

To prevent personal injury or damage to property, halogen lamps may only be operated in suitable luminaires designed with suitable mechanisms (cover panel etc.) to ensure that in the event of a lamp bursting no parts/shards can escape and that during operation no ultraviolet radiation can escape. Because of the heat produced only heat-resistant lamp connections (holders) may be used. Do not operate near people, or any materials that are flammable, sensitive to heat or affected by drying out. Detailed information is available on request.

Logistical Data

Product code	Product description	Packaging unit (Pieces/Unit)	Dimensions (length x width x height)	Volume	Gross weight
4062172359252	PAR64 64739/4 MFL	Folding carton box 1	179 mm x 179 mm x 204 mm	6.54 dm ³	1069.00 g
4062172359269	PAR64 64739/4 MFL	Shipping carton box 6	594 mm x 411 mm x 265 mm	64.70 dm ³	7454.00 g

The mentioned product code describes the smallest quantity unit which can be ordered. One shipping unit can contain one or more single products. When placing an order, for the quantity please enter single or multiples of a shipping unit.

Disclaimer

Subject to change without notice. Errors and omission excepted. Always make sure to use the most recent release.
