

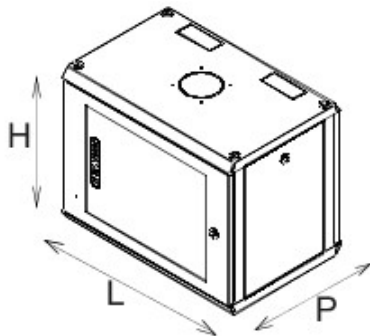

A complete system for the connection and distribution of LAN networks in the residential and tertiary sector. The range includes solutions for optical fibre, wall cabinets, floor-standing cabinets and products for copper wiring. The Data Center cabinets come with a wide choice of configurations and various depths (up to 1000mm) to meet every application need. Made of top quality materials (static full-load capacity up to 1000kg), these products guarantee easy wiring (thanks to the notable internal space) and can be completely customised with removable and reversible front doors.

Catégorie	19" wall-mount cabinet	Matière	Acier
Finition	Textured	Couleur	Grey (RAL 7035)
Unité de câblage	15 U	Type de porte	Reversible
Apertura porta	180°	Portata statica	50 kilogramme
No. uprights	2	Profondeur (mm)	400 mm
Dim. externes LxHxP (mm)	600x740x400	Indice de protection	IP20
Electrocod	3752		

DIMENSIONS



	H	L	P	
GW 38 406	335	600	400	6U
GW 38 407	470	600	400	9U
GW 38 408	605	600	400	12U
GW 38 409	740	600	400	15U
GW 38 418	605	600	600	12U
GW 38 419	740	600	600	15U

SYMBOLE TECHNIQUE

IP

IP20

NORMES ET HOMOLOGATIONS



GEWISS S.A.S. 1, Rue du Rio Salado 91940
Les Ulis Cedex
Tel : +33 1 64 86 80 80

www.gewiss.com
www.gewiss@gewiss.fr
Dernière mise à jour 15/01/2020

Les caractéristiques, dimensions, dessins et images sont communiqués à titre purement informatif et peuvent faire l'objet de modification sans aucun préavis