

1)

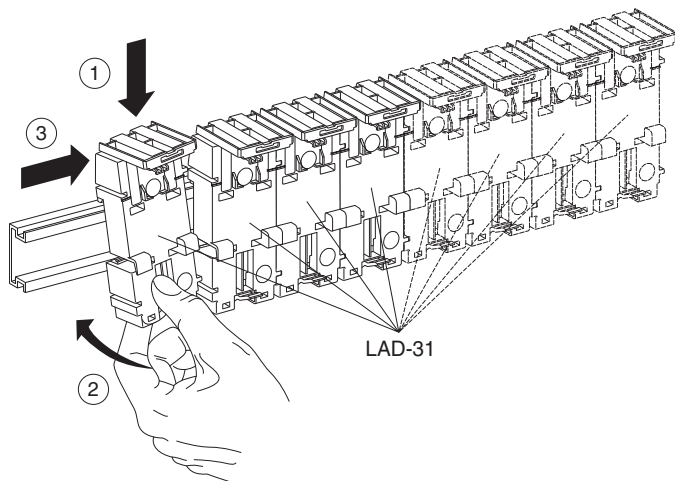

2)

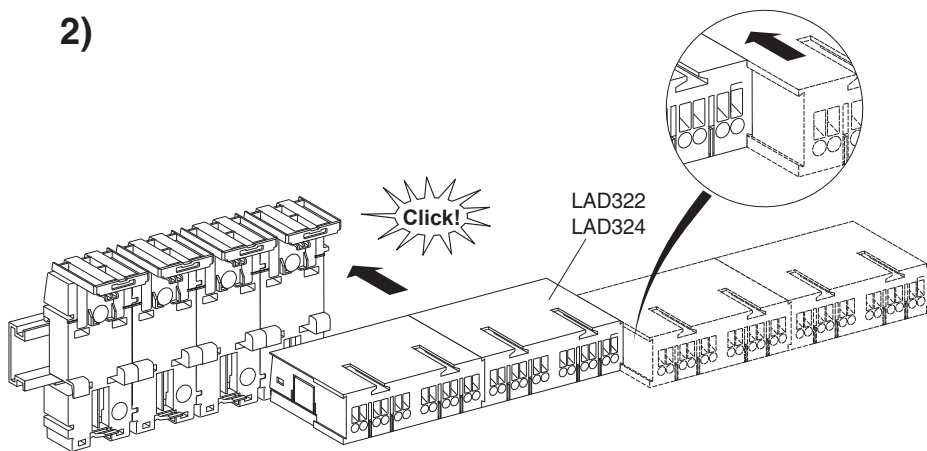

Schneider Electric Industries SAS
35, rue Joseph Monier
92506 Rueil Malmaison
France

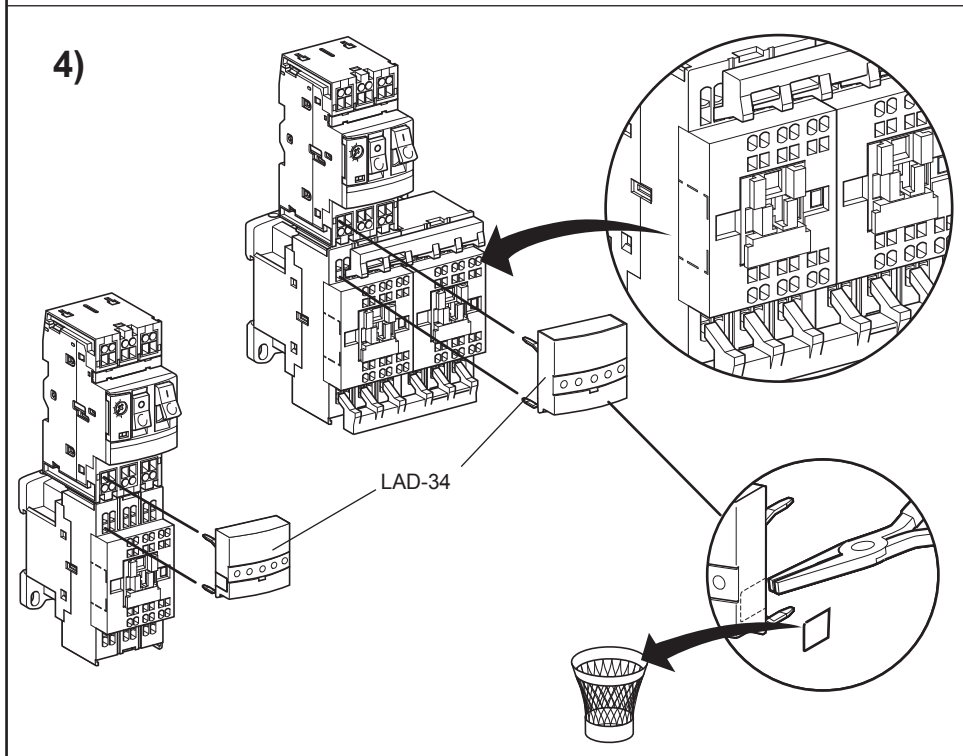
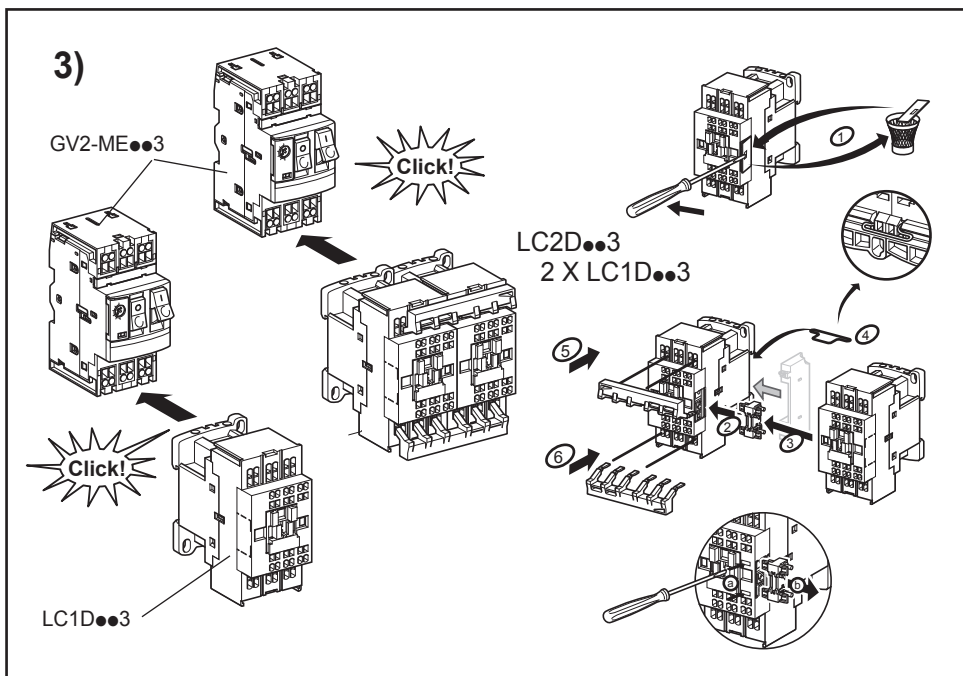

5)

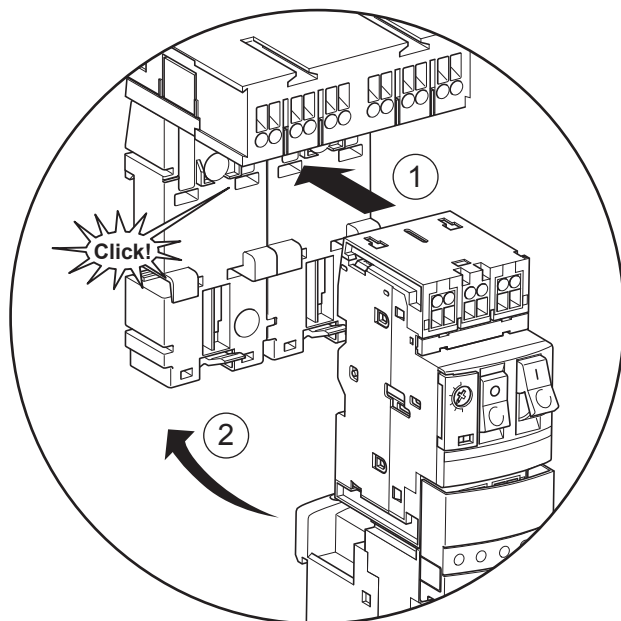
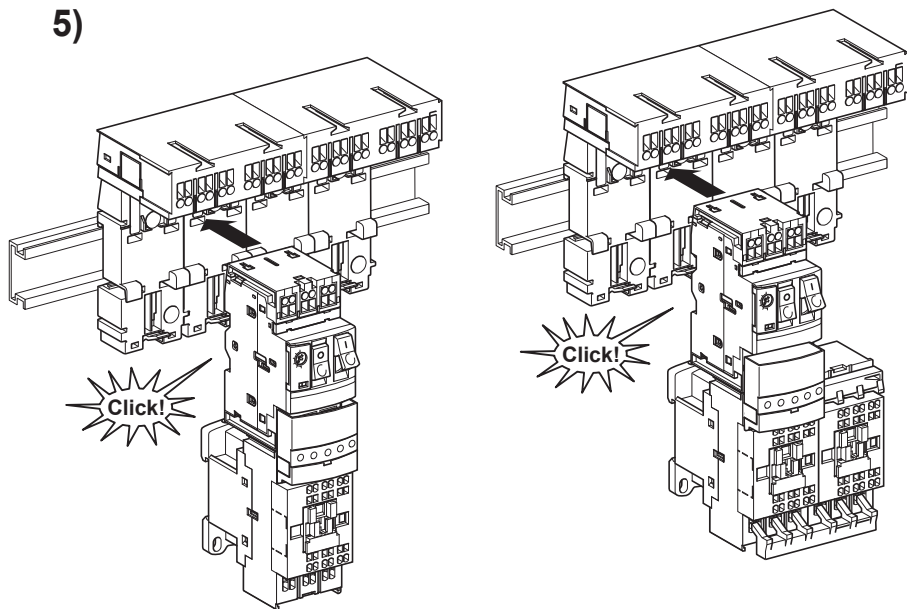

6)

$I < 25A / 4mm^2$

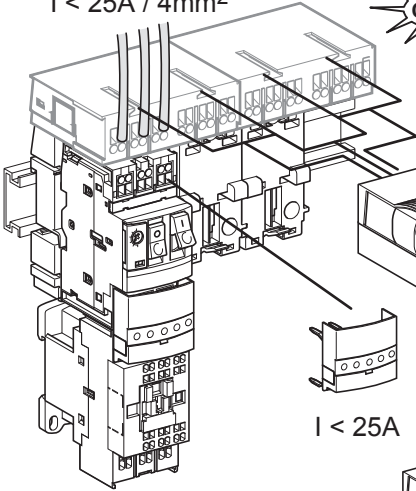

LAD-3B



$I 60A$

$I < 25A$

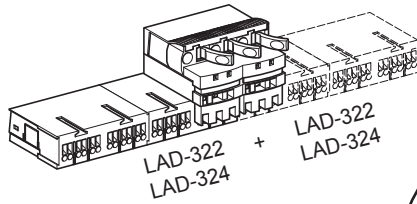
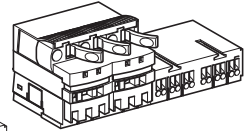
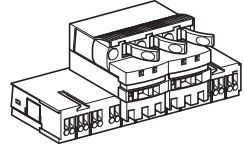
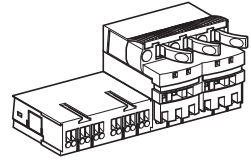

LAD-322 + LAD-324
LAD-324

7)

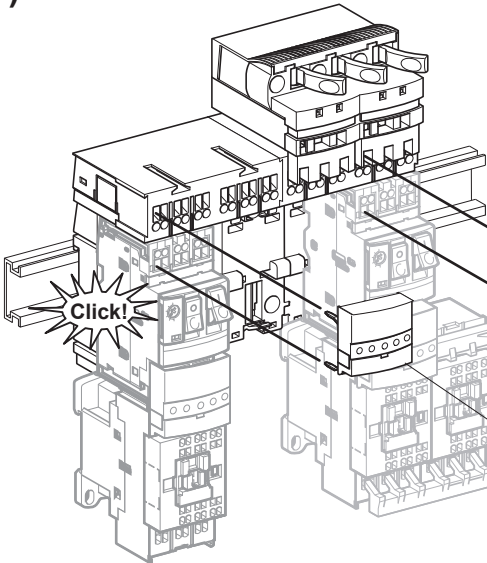

Click!

LAD-34

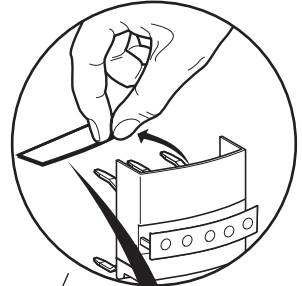

8)

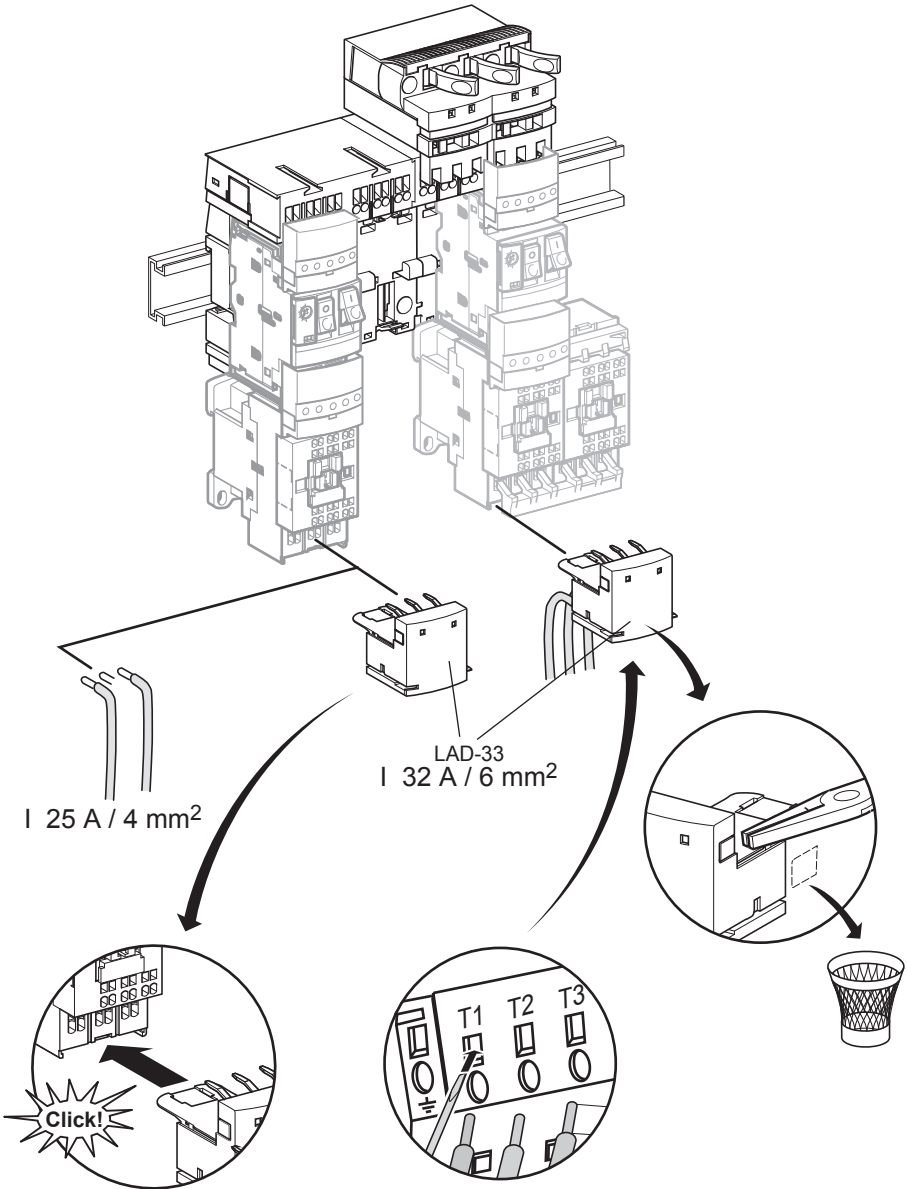

9)

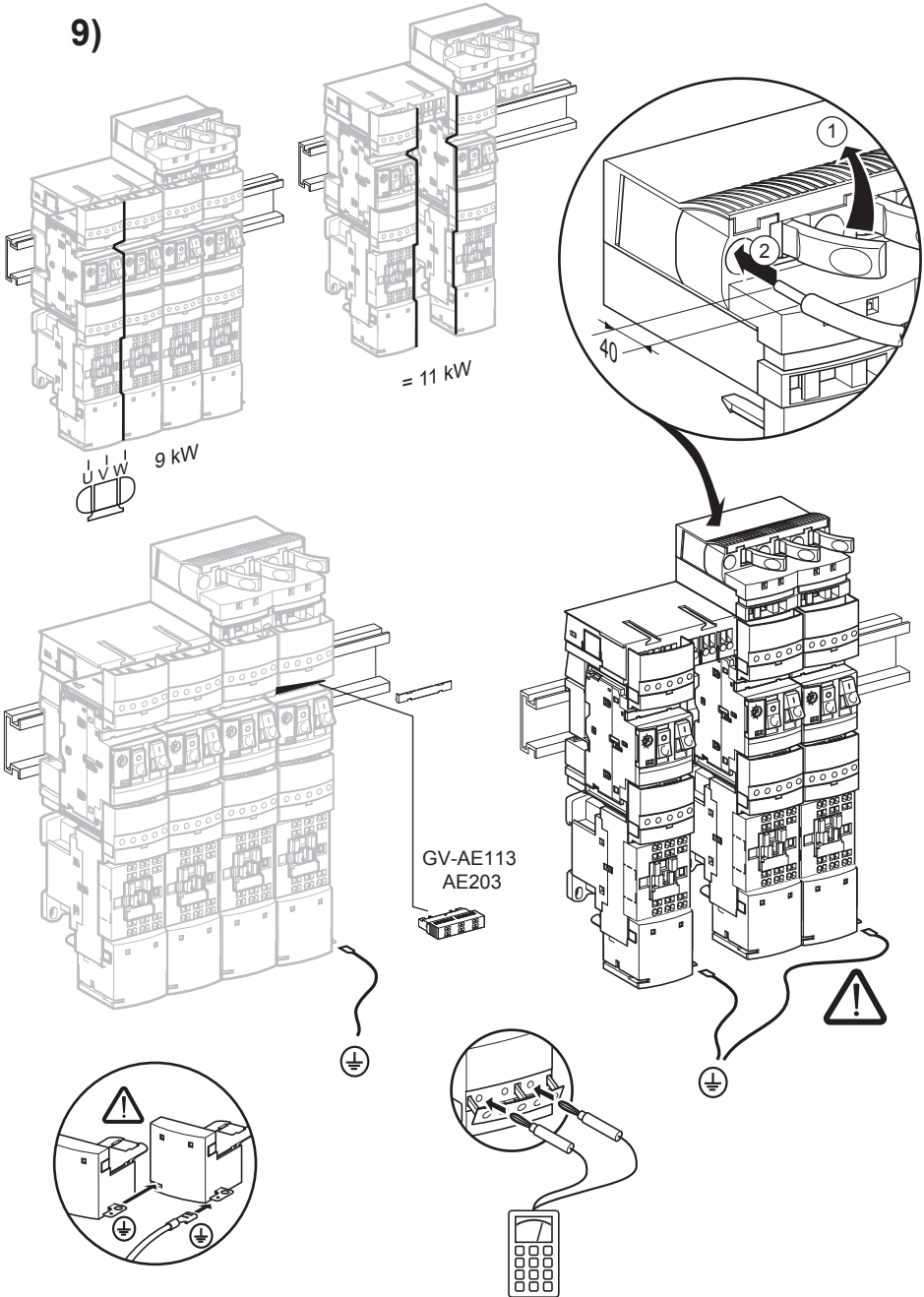

OFF



1

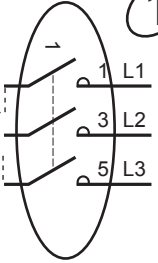

2

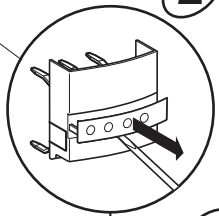

3

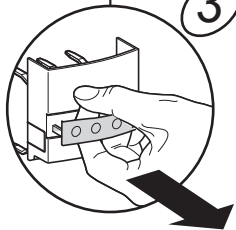

4



5

