



# WL11G-2K3431

## W11G-2

SMALL PHOTOELECTRIC SENSORS

**SICK**  
Sensor Intelligence.



Illustration may differ



## Ordering information

Type	Part no.
WL11G-2K3431	1048313

Other models and accessories → [www.sick.com/W11G-2](http://www.sick.com/W11G-2)

## Detailed technical data

### Features

<b>Functional principle</b>	Photoelectric retro-reflective sensor
<b>Functional principle detail</b>	Autocollimation
<b>Dimensions (W x H x D)</b>	15.6 mm x 48.5 mm x 42 mm
<b>Housing design (light emission)</b>	Rectangular
<b>Sensing range max.</b>	0 m ... 4 m <sup>1)</sup>
<b>Sensing range</b>	0 m ... 4 m <sup>1)</sup>
<b>Focus</b>	Approx. 1.5°
<b>Type of light</b>	Visible red light
<b>Light source</b>	LED <sup>2)</sup>
<b>Light spot size (distance)</b>	Ø 25 mm (1.5 m)
<b>Angle of dispersion</b>	Approx. 1.5°
<b>Wave length</b>	640 nm
<b>Adjustment</b>	Potentiometer, 11 turns
<b>Special feature</b>	Detecting transparent objects
<b>Special applications</b>	Detecting transparent objects

<sup>1)</sup> Reflector PL80A.

<sup>2)</sup> Average service life: 100,000 h at T<sub>U</sub> = +25 °C.

## Mechanics/electronics

<b>Supply voltage <math>U_B</math></b>	10 V DC ... 30 V DC <sup>1)</sup>
<b>Ripple</b>	< 5 V <sub>pp</sub> <sup>2)</sup>
<b>Current consumption</b>	30 mA <sup>3)</sup>
<b>Switching output</b>	PNP <sup>4) 5) 6)</sup>
<b>Output function</b>	Complementary
<b>Switching mode</b>	Light/dark switching <sup>4) 5) 6)</sup>
<b>Signal voltage PNP HIGH/LOW</b>	U <sub>v</sub> - 3 V / approx. 0 V
<b>Output current I<sub>max</sub></b>	≤ 100 mA
<b>Response time</b>	≤ 330 μs <sup>7)</sup>
<b>Switching frequency</b>	1,500 Hz <sup>8)</sup>
<b>Attenuation along light beam</b>	> 8 %
<b>Connection type</b>	Cable with M12 male connector, 4-pin, 270 mm
<b>Cable material</b>	PVC
<b>Conductor cross section</b>	0.25 mm <sup>2</sup>
<b>Circuit protection</b>	A <sup>9)</sup> C <sup>10)</sup> D <sup>11)</sup>
<b>Protection class</b>	II
<b>Polarisation filter</b>	✓
<b>Housing material</b>	Plastic, ABS
<b>Optics material</b>	Plastic, PMMA
<b>Enclosure rating</b>	IP66 IP67 IP69K
<b>Special feature</b>	Detecting transparent objects
<b>Ambient operating temperature</b>	-30 °C ... +60 °C
<b>Ambient temperature, storage</b>	-40 °C ... +75 °C
<b>UL File No.</b>	NRKH.E181493 & NRKH7.E181493

<sup>1)</sup> Limit values when operated in short-circuit protected network: max. 8 A.

<sup>2)</sup> May not exceed or fall below U<sub>v</sub> tolerances.

<sup>3)</sup> Without load.

<sup>4)</sup> Pin 2 and pin 4 swapped over.

<sup>5)</sup> 0 V or not connected, light switching.

<sup>6)</sup> U<sub>v</sub>, dark switching.

<sup>7)</sup> Signal transit time with resistive load.

<sup>8)</sup> With light/dark ratio 1:1.

<sup>9)</sup> A = V<sub>S</sub> connections reverse-polarity protected.

<sup>10)</sup> C = interference suppression.

<sup>11)</sup> D = outputs overcurrent and short-circuit protected.

## Safety-related parameters

<b>MTTF<sub>D</sub></b>	823 years
<b>DC<sub>avg</sub></b>	0 %

Classifications

<b>ECLASS 5.0</b>	27270902
<b>ECLASS 5.1.4</b>	27270902
<b>ECLASS 6.0</b>	27270902
<b>ECLASS 6.2</b>	27270902
<b>ECLASS 7.0</b>	27270902
<b>ECLASS 8.0</b>	27270902
<b>ECLASS 8.1</b>	27270902
<b>ECLASS 9.0</b>	27270902
<b>ECLASS 10.0</b>	27270902
<b>ECLASS 11.0</b>	27270902
<b>ECLASS 12.0</b>	27270902
<b>ETIM 5.0</b>	EC002717
<b>ETIM 6.0</b>	EC002717
<b>ETIM 7.0</b>	EC002717
<b>ETIM 8.0</b>	EC002717
<b>UNSPSC 16.0901</b>	39121528

Dimensional drawing (Dimensions in mm (inch))

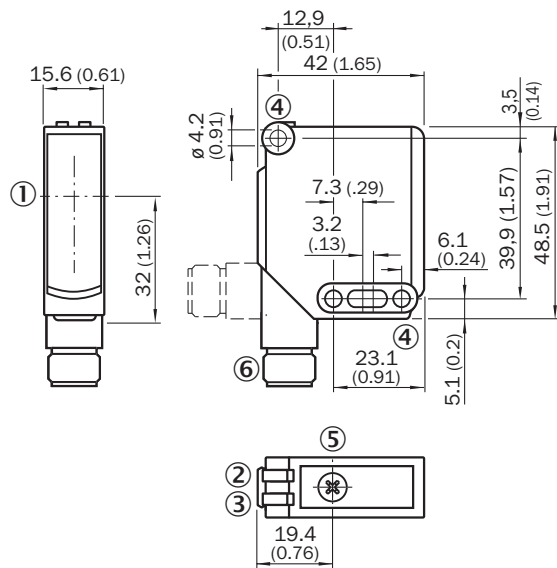

- ① Center of optical axis
- ② LED indicator green: Supply voltage active
- ③ LED indicator yellow: Status of received light beam
- ④ Mounting hole  $\varnothing 4.2$  mm
- ⑤ Sensitivity control: potentiometer
- ⑥ Male connector M12, cable with male connector M12 or cable

## Adjustments

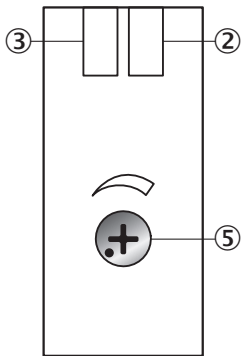

- ② LED indicator green: Supply voltage active
- ③ LED indicator yellow: Status of received light beam
- ⑤ Sensitivity control

## Connection type

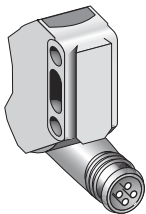

## Connection diagram

Cd-101

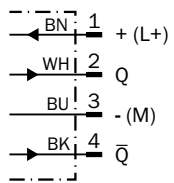

Characteristic curve

WL11G-2

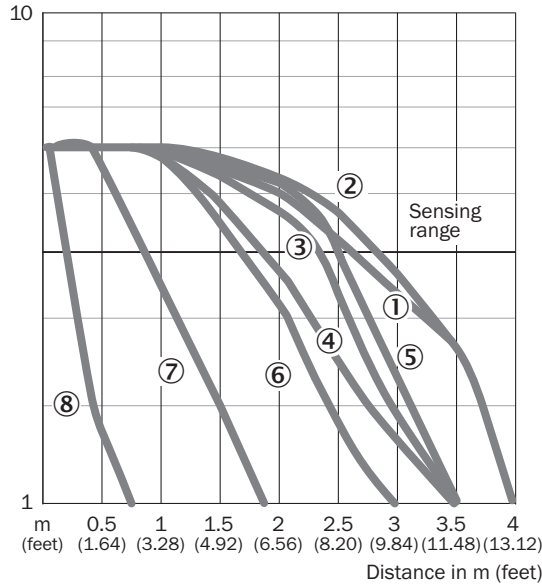

- ① Reflector PL80A
- ② Reflector C110A
- ③ Reflector P250F
- ④ Reflector PL50A
- ⑤ Reflector PL40A
- ⑥ Reflector PL30A
- ⑦ Reflector PL20A
- ⑧ Reflective tape Diamond Grade

Sensing range diagram



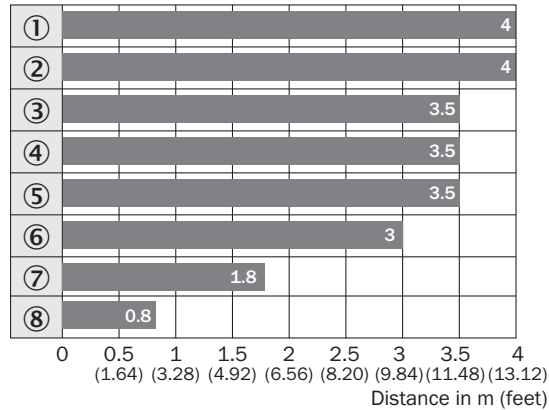

WL11G-2



- Sensing range
- ① Reflector PL80A
- ② Reflector C110A
- ③ Reflector P250F
- ④ Reflector PL50A
- ⑤ Reflector PL40A
- ⑥ Reflector PL30A
- ⑦ Reflector PL20A
- ⑧ Reflective tape Diamond Grade

## Recommended accessories

Other models and accessories → [www.sick.com/W11G-2](http://www.sick.com/W11G-2)

	Brief description	Type	Part no.
Mounting brackets and plates			
	Mounting bracket, large, stainless steel, mounting hardware included	BEF-WG-W12	2013942
	Universal mounting bracket for reflectors, steel, zinc coated	BEF-WN-REFX	2064574
Plug connectors and cables			
	<ul style="list-style-type: none"> <li>• <b>Connection type head A:</b> Male connector, M12, 4-pin, straight</li> <li>• <b>Description:</b> Unshielded</li> <li>• <b>Connection systems:</b> Screw-type terminals</li> <li>• <b>Permitted cross-section:</b> ≤ 0.75 mm<sup>2</sup></li> </ul>	STE-1204-G	6009932
Reflectors			
	Rectangular, screw connection, 51 mm x 61 mm, PMMA/ABS, Screw-on, 2 hole mounting	P250	5304812
Others			
	<ul style="list-style-type: none"> <li>• <b>Connection type head A:</b> Female connector, M12, 4-pin, straight, A-coded</li> <li>• <b>Connection type head B:</b> Flying leads</li> <li>• <b>Signal type:</b> Sensor/actuator cable</li> <li>• <b>Cable:</b> 5 m, 4-wire, PVC</li> <li>• <b>Description:</b> Sensor/actuator cable, unshielded</li> <li>• <b>Application:</b> Zones with chemicals</li> </ul>	YF2A14-050VB3XLEAX	2096235

## SICK AT A GLANCE

SICK is one of the leading manufacturers of intelligent sensors and sensor solutions for industrial applications. A unique range of products and services creates the perfect basis for controlling processes securely and efficiently, protecting individuals from accidents and preventing damage to the environment.

We have extensive experience in a wide range of industries and understand their processes and requirements. With intelligent sensors, we can deliver exactly what our customers need. In application centers in Europe, Asia and North America, system solutions are tested and optimized in accordance with customer specifications. All this makes us a reliable supplier and development partner.

Comprehensive services complete our offering: SICK LifeTime Services provide support throughout the machine life cycle and ensure safety and productivity.

For us, that is “Sensor Intelligence.”

## WORLDWIDE PRESENCE:

Contacts and other locations –[www.sick.com](http://www.sick.com)