



IME30-15BNOZC0K

IME

INDUCTIVE PROXIMITY SENSORS

SICK
Sensor Intelligence.



Illustration may differ



Ordering information

| Type | Part no. |
|-----------------|----------|
| IME30-15BNOZC0K | 1041041 |

Included in delivery: BEF-MU-M30 (1)

Other models and accessories → www.sick.com/IME

Detailed technical data

Features

| | |
|--|---|
| Housing | Cylindrical thread design |
| Housing | Short-body |
| Thread size | M30 x 1.5 |
| Diameter | Ø 30 mm |
| Sensing range S_n | 15 mm |
| Safe sensing range S_a | 12.15 mm |
| Installation type | Flush |
| Switching frequency | 500 Hz |
| Connection type | Male connector M12, 4-pin |
| Switching output | NPN |
| Output function | NC |
| Electrical wiring | DC 3-wire |
| Enclosure rating | IP67 ¹⁾ |
| Items supplied | Mounting nut, brass, nickel-plated (2x) |

¹⁾ According to EN 60529.

Mechanics/electronics

| | |
|---------------------------------------|---------------------|
| Supply voltage | 10 V DC ... 30 V DC |
| Ripple | ≤ 10 % |
| Voltage drop | ≤ 2 V ¹⁾ |
| Time delay before availability | ≤ 125 ms |

¹⁾ At I_a max.

²⁾ Supply voltage U_B and constant ambient temperature T_a .

³⁾ Of S_r .

| | |
|---|-----------------------------------|
| Hysteresis | 3 % ... 15 % |
| Reproducibility | ≤ 2 % ^{2) 3)} |
| Temperature drift (of S_r) | ± 10 % |
| EMC | According to EN 60947-5-2 |
| Continuous current I_a | ≤ 200 mA |
| No load current | ≤ 10 mA |
| Short-circuit protection | ✓ |
| Reverse polarity protection | ✓ |
| Power-up pulse protection | ✓ |
| Shock and vibration resistance | 30 g, 11 ms/10 Hz ... 55 Hz, 1 mm |
| Ambient operating temperature | -25 °C ... +75 °C |
| Housing material | Brass, nickel-plated |
| Sensing face material | Plastic, PA 66 |
| Housing length | 52 mm |
| Thread length | 35 mm |
| Tightening torque, max. | ≤ 100 Nm |
| UL File No. | NRKH.E181493 |

¹⁾ At I_a max.

²⁾ Supply voltage U_B and constant ambient temperature T_a.

³⁾ Of S_r.

Safety-related parameters

| | |
|-------------------------|-------------|
| MTTF_D | 1,735 years |
| DC_{avg} | 0 % |

Reduction factors

| | |
|-----------------------------------|--|
| Note | The values are reference values which may vary |
| St37 steel (Fe) | 1 |
| Stainless steel (V2A, 304) | Approx. 0.8 |
| Aluminum (Al) | Approx. 0.45 |
| Copper (Cu) | Approx. 0.4 |
| Brass (Br) | Approx. 0.4 |

Installation note

| | |
|---------------|---------------------------------------|
| Remark | Associated graphic see "Installation" |
| B | 60 mm |
| C | 30 mm |
| D | 45 mm |
| F | 120 mm |

Classifications

| | |
|---------------------|----------|
| ECLASS 5.0 | 27270101 |
| ECLASS 5.1.4 | 27270101 |
| ECLASS 6.0 | 27270101 |

| | |
|-----------------------|----------|
| ECLASS 6.2 | 27270101 |
| ECLASS 7.0 | 27270101 |
| ECLASS 8.0 | 27270101 |
| ECLASS 8.1 | 27270101 |
| ECLASS 9.0 | 27270101 |
| ECLASS 10.0 | 27270101 |
| ECLASS 11.0 | 27270101 |
| ECLASS 12.0 | 27274001 |
| ETIM 5.0 | EC002714 |
| ETIM 6.0 | EC002714 |
| ETIM 7.0 | EC002714 |
| ETIM 8.0 | EC002714 |
| UNSPSC 16.0901 | 39122230 |

Installation note

Flush installation



Connection type

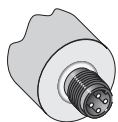

Connection diagram

Cd-008

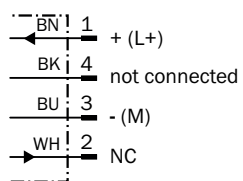

Dimensional drawing (Dimensions in mm (inch))



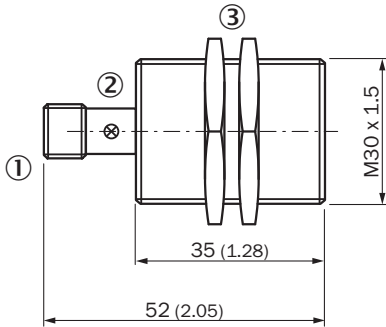



IME30 Short-body housing, connector, flush







- ① Connection
- ② Display LED
- ③ Fastening nuts (2x); width across 36, metal

Recommended accessories

Other models and accessories → www.sick.com/IME

| | Brief description | Type | Part no. |
|---|---|--------------------|----------|
| Mounting brackets and plates | | | |
|  | Mounting plate for M30 sensors, steel, zinc coated, without mounting hardware | BEF-WG-M30 | 5321871 |
|  | Mounting bracket for M30 sensors, steel, zinc coated, without mounting hardware | BEF-WN-M30 | 5308445 |
| Plug connectors and cables | | | |
|  | <ul style="list-style-type: none"> • Connection type head A: Female connector, M12, 4-pin, straight • Description: Unshielded, Head A: female connector, M12, 4-pin, straight, unshielded, for power supply, for cable diameter 4 mm ... 6 mm Head B: - • Connection systems: Screw-type terminals • Permitted cross-section: ≤ 0.75 mm² | DOS-1204-G | 6007302 |
|  | <ul style="list-style-type: none"> • Connection type head A: Female connector, M12, 4-pin, angled • Description: Unshielded, Head A: female connector, M12, 4-pin, angled, unshielded, for power supply, for cable diameter 3 mm ... 6.5 mm Head B: - • Connection systems: Screw-type terminals • Permitted cross-section: ≤ 0.75 mm² | DOS-1204-W | 6007303 |
| Others | | | |
|  | <ul style="list-style-type: none"> • Connection type head A: Female connector, M12, 4-pin, straight, A-coded • Connection type head B: Flying leads • Signal type: Sensor/actuator cable • Cable: 2 m, 4-wire, PVC • Description: Sensor/actuator cable, unshielded • Application: Zones with chemicals | YF2A14-020VB3XLEAX | 2096234 |
|  | <ul style="list-style-type: none"> • Connection type head A: Female connector, M12, 4-pin, straight, A-coded • Connection type head B: Flying leads • Signal type: Sensor/actuator cable • Cable: 5 m, 4-wire, PVC • Description: Sensor/actuator cable, unshielded • Application: Zones with chemicals | YF2A14-050VB3XLEAX | 2096235 |

| | Brief description | Type | Part no. |
|---|--|--------------------|----------|
|  | <ul style="list-style-type: none"> • Connection type head A: Female connector, M12, 4-pin, straight, A-coded • Connection type head B: Flying leads • Signal type: Sensor/actuator cable • Cable: 10 m, 4-wire, PVC • Description: Sensor/actuator cable, unshielded • Application: Zones with chemicals | YF2A14-100VB3XLEAX | 2096236 |
|  | <ul style="list-style-type: none"> • Connection type head A: Female connector, M12, 4-pin, angled, A-coded • Connection type head B: Flying leads • Signal type: Sensor/actuator cable • Cable: 2 m, 4-wire, PVC • Description: Sensor/actuator cable, unshielded • Application: Zones with chemicals | YG2A14-020VB3XLEAX | 2095895 |
|  | <ul style="list-style-type: none"> • Connection type head A: Female connector, M12, 4-pin, angled, A-coded • Connection type head B: Flying leads • Signal type: Sensor/actuator cable • Cable: 5 m, 4-wire, PVC • Description: Sensor/actuator cable, unshielded • Application: Zones with chemicals | YG2A14-050VB3XLEAX | 2095897 |
|  | <ul style="list-style-type: none"> • Connection type head A: Female connector, M12, 4-pin, angled, A-coded • Connection type head B: Flying leads • Signal type: Sensor/actuator cable • Cable: 10 m, 4-wire, PVC • Description: Sensor/actuator cable, unshielded • Application: Zones with chemicals | YG2A14-100VB3XLEAX | 2095898 |

SICK AT A GLANCE

SICK is one of the leading manufacturers of intelligent sensors and sensor solutions for industrial applications. A unique range of products and services creates the perfect basis for controlling processes securely and efficiently, protecting individuals from accidents and preventing damage to the environment.

We have extensive experience in a wide range of industries and understand their processes and requirements. With intelligent sensors, we can deliver exactly what our customers need. In application centers in Europe, Asia and North America, system solutions are tested and optimized in accordance with customer specifications. All this makes us a reliable supplier and development partner.

Comprehensive services complete our offering: SICK LifeTime Services provide support throughout the machine life cycle and ensure safety and productivity.

For us, that is “Sensor Intelligence.”

WORLDWIDE PRESENCE:

Contacts and other locations –www.sick.com