

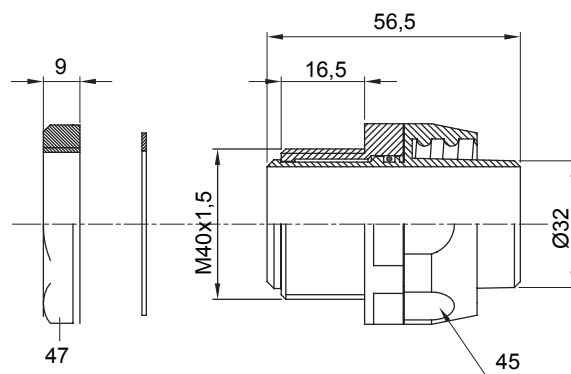

Raccord tournant droit pour gaine avec degré de protection IP54.

Couleur	Noir RAL 9005	Indice de protection	IP54
Pas métrique	M 40x1,5	Gaine Ø (mm)	32
Type	Tournant	Electrocod	210

DIMENSIONS



SYMBOLE TECHNIQUE

IP

IP54

NORMES ET HOMOLOGATIONS

