



# M2C-SA0250LA10

deTem

**SAFETY MULTIBEAM SENSORS**

**SICK**  
Sensor Intelligence.



### Ordering information

deTem2 Core

| Scanning range | Number of beams | Beam separation | System part | Type           | Part no. |
|----------------|-----------------|-----------------|-------------|----------------|----------|
| 17 m           | 2               | 500 mm          | Sender      | M2C-SA0250LA10 | 1085562  |

Other models and accessories → [www.sick.com/deTem](http://www.sick.com/deTem)

Illustration may differ



### Detailed technical data

#### Features

|                                    |                               |
|------------------------------------|-------------------------------|
| <b>Application</b>                 | Normal industrial environment |
| <b>Functional principle</b>        | Sender/receiver               |
| <b>System part</b>                 | Sender                        |
| <b>Scanning range</b>              | 17 m                          |
| <b>Dimension of the light path</b> |                               |
| Minimum                            | 0.5 m ... 15 m                |
| Typical                            | 0.5 m ... 17 m                |
| <b>Number of beams</b>             | 2                             |
| <b>Beam separation</b>             | 500 mm                        |
| <b>Synchronization</b>             | Optical synchronisation       |
| <b>Items supplied</b>              | Sender                        |

#### Safety-related parameters

|   |  |
|---|--|
| <b>Type</b>   | Type 2 (IEC 61496-1)                   |
| <b>Safety integrity level</b>   | SIL 1 (IEC 61508)                      |
| <b>Category</b>   | Category 2 (ISO 13849-1)               |
| <b>Performance level</b>  | PL c (ISO 13849-1)                     |
| <b>PFH<sub>D</sub> (mean probability of a dangerous failure per hour)</b> | $3 \times 10^{-9}$                     |
| <b>T<sub>M</sub> (mission time)</b>                                       | 20 years (ISO 13849-1)                 |
| <b>Safe state in the event of a fault</b>                                 | At least one OSSD is in the OFF state. |

#### Interfaces

|  |                           |
|--|---------------------------|
| <b>System connection</b>                 | Male connector M12, 5-pin |
| Flexi Loop compatible M12 male connector | ✓                         |
| Permitted cable length                   | 50 m                      |
| <b>Display elements</b>                  | LEDs                      |

## Electrical data

|                                     |   |
|-------------------------------------|---|
| <b>Protection class</b>             | III (IEC 61140) <sup>1)</sup>                   |
| <b>Supply voltage V<sub>S</sub></b> | 24 V DC (19.2 V DC ... 28.8 V DC) <sup>2)</sup> |
| <b>Residual ripple</b>              | ≤ 10 % <sup>3)</sup>                            |
| <b>Power consumption</b>            | ≤ 50 mA   |
| <b>Power consumption</b>            | ≤ 1.44 W (DC)                                   |

<sup>1)</sup> SELV/PELV safety/protective extra-low voltage.

<sup>2)</sup> The external voltage supply must be capable of buffering brief mains voltage failures of 20 ms as specified in EN 60204-1. Suitable power supplies are available as accessories from SICK.

<sup>3)</sup> Within the limits of V<sub>S</sub>.

## Mechanical data

|                              |  |
|------------------------------|--|
| <b>Dimensions</b>            | See dimensional drawing                  |
| <b>Housing cross-section</b> | 31 mm x 34 mm                            |
| <b>Material</b>              |  |
| Housing                      | Aluminum extruded profile                |
| Front screen                 | Polycarbonate, scratch-resistant coating |
| <b>Weight</b>                | 560 g (± 50 g)                           |
| <b>Cable bend radius</b>     |  |
| Stationary position          | > 12 x cable diameter                    |
| Flexible use                 | > 15 x cable diameter                    |

## Ambient data

|                                      |                                      |
|--------------------------------------|--------------------------------------|
| <b>Enclosure rating</b>              | IP65 (IEC 60529)<br>IP67 (IEC 60529) |
| <b>Ambient operating temperature</b> | -30 °C ... +55 °C                    |
| <b>Storage temperature</b>           | -30 °C ... +70 °C                    |
| <b>Air humidity</b>                  | 15 % ... 95 %, Non-condensing        |
| <b>Vibration resistance</b>          | 5 g, 10 Hz ... 55 Hz (IEC 60068-2-6) |
| <b>Shock resistance</b>              | 10 g, 16 ms (IEC 60068-2-27)         |

## Other information

|                      |                                |
|----------------------|--------------------------------|
| <b>Type of light</b> | Near-infrared (NIR), invisible |
|----------------------|--------------------------------|

## Classifications

|                     |          |
|---------------------|----------|
| <b>eCl@ss 5.0</b>   | 27272703 |
| <b>eCl@ss 5.1.4</b> | 27272703 |
| <b>eCl@ss 6.0</b>   | 27272703 |
| <b>eCl@ss 6.2</b>   | 27272703 |
| <b>eCl@ss 7.0</b>   | 27272703 |
| <b>eCl@ss 8.0</b>   | 27272703 |
| <b>eCl@ss 8.1</b>   | 27272703 |
| <b>eCl@ss 9.0</b>   | 27272703 |
| <b>eCl@ss 10.0</b>  | 27272703 |
| <b>eCl@ss 11.0</b>  | 27272703 |
| <b>eCl@ss 12.0</b>  | 27272703 |

|                       |          |
|-----------------------|----------|
| <b>ETIM 5.0</b>       | EC001832 |
| <b>ETIM 6.0</b>       | EC001832 |
| <b>ETIM 7.0</b>       | EC001832 |
| <b>ETIM 8.0</b>       | EC001832 |
| <b>UNSPSC 16.0901</b> | 46171620 |

### Dimensional drawing (Dimensions in mm (inch))

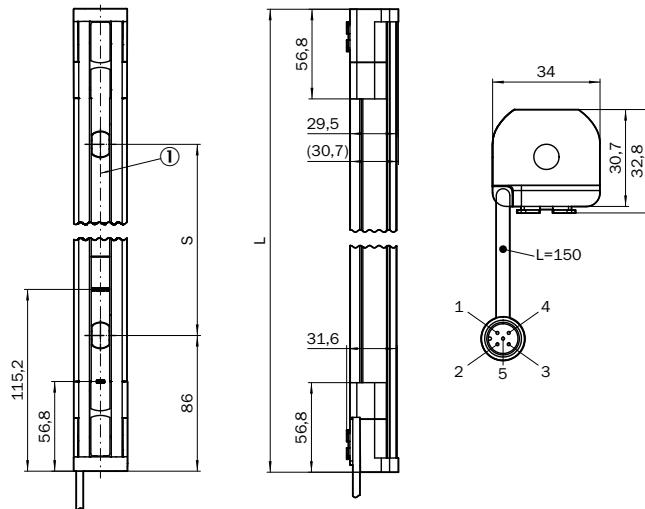







① Optical axis

| Number of beams | Beam separation S | Length L     |
|-----------------|-------------------|--------------|
| 2               | 500 (19.69)       | 672 (26.46)  |
| 3               | 400 (15.75)       | 972 (38.27)  |
| 4               | 300 (11.81)       | 1,072 (42.2) |

### Recommended accessories

Other models and accessories → [www.sick.com/deTem](http://www.sick.com/deTem)

| Brief description   | Type               | Part no. |
|---|--------------------|----------|
| Plug connectors and cables  |                    |          |
|  Head A: female connector, M12, 5-pin, straight, A-coded<br>Head B: Flying leads<br>Cable: Sensor/actuator cable, PUR, halogen-free, unshielded, 2 m | YF2A15-020UB5XLEAX | 2095617  |
| Head A: female connector, M12, 5-pin, straight, A-coded<br>Head B: Flying leads<br>Cable: Sensor/actuator cable, PUR, halogen-free, unshielded, 5 m   | YF2A15-050UB5XLEAX | 2095618  |
| Head A: female connector, M12, 5-pin, straight, A-coded<br>Head B: Flying leads<br>Cable: Sensor/actuator cable, PUR, halogen-free, unshielded, 10 m  | YF2A15-100UB5XLEAX | 2095619  |

|  | Brief description   | Type               | Part no. |
|--|---|--------------------|----------|
|   | Head A: female connector, M12, 5-pin, straight, A-coded<br>Head B: male connector, M12, 5-pin, straight, A-coded<br>Cable: Sensor/actuator cable, PUR, halogen-free, unshielded, 2 m  | YF2A15-020UB5M2A15 | 2096009  |
|  | Head A: female connector, M12, 5-pin, straight, A-coded<br>Head B: male connector, M12, 5-pin, straight, A-coded<br>Cable: Sensor/actuator cable, PUR, halogen-free, unshielded, 5 m  | YF2A15-050UB5M2A15 | 2096010  |
|  | Head A: female connector, M12, 5-pin, straight, A-coded<br>Head B: male connector, M12, 5-pin, straight, A-coded<br>Cable: Sensor/actuator cable, PUR, halogen-free, unshielded, 10 m   | YF2A15-100UB5M2A15 | 2096011  |
| Terminal and alignment brackets  |   |                    |          |
|   | 4 pieces, FlexFix bracket for 2 devices (e.g. sender and receiver), can be aligned $\pm 15^\circ$ , including M5 screw, plastic   | BEF-1SHABPKU4      | 2066614  |
|   | 4 pieces, QuickFix bracket for 2 devices (e.g. sender and receiver), plastic  | BEF-3SHABPKU4      | 2098710  |
| Safety switching amplifier   |   |                    |          |
|   | <ul style="list-style-type: none"> <li>• <b>Applications:</b> Evaluation unit</li> <li>• <b>Compatible sensor types:</b> Safety sensors with OSSDs</li> <li>• <b>Connection type:</b> Front connector with spring terminals</li> <li>• <b>Restart interlock:</b> yes</li> <li>• <b>External device monitoring (EDM):</b> Integrated</li> <li>• <b>Outputs:</b> 2 enabling current paths (safe), 2 application diagnostic outputs (not safe), 1 test pulse output (not safe)</li> <li>• <b>Housing width:</b> 18 mm</li> </ul> | RLY3-OSSD200       | 1085344  |
|  | <ul style="list-style-type: none"> <li>• <b>Applications:</b> Evaluation unit</li> <li>• <b>Compatible sensor types:</b> Safety sensors with OSSDs</li> <li>• <b>Connection type:</b> Front connector with spring terminals</li> <li>• <b>Restart interlock:</b> yes</li> <li>• <b>External device monitoring (EDM):</b> Integrated</li> <li>• <b>Outputs:</b> 3 enabling current paths (safe), 2 application diagnostic outputs (not safe), 1 test pulse output (not safe)</li> <li>• <b>Housing width:</b> 18 mm</li> </ul> | RLY3-OSSD300       | 1099969  |

## SICK AT A GLANCE

SICK is one of the leading manufacturers of intelligent sensors and sensor solutions for industrial applications. A unique range of products and services creates the perfect basis for controlling processes securely and efficiently, protecting individuals from accidents and preventing damage to the environment.

We have extensive experience in a wide range of industries and understand their processes and requirements. With intelligent sensors, we can deliver exactly what our customers need. In application centers in Europe, Asia and North America, system solutions are tested and optimized in accordance with customer specifications. All this makes us a reliable supplier and development partner.

Comprehensive services complete our offering: SICK LifeTime Services provide support throughout the machine life cycle and ensure safety and productivity.

For us, that is “Sensor Intelligence.”

## WORLDWIDE PRESENCE:

Contacts and other locations –[www.sick.com](http://www.sick.com)