

27000...78

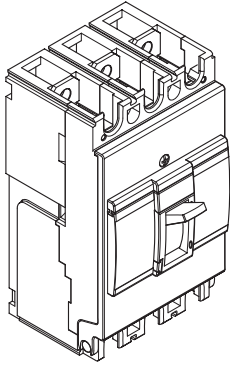

Le non respect des indications de la présente notice ne saurait engager la responsabilité du constructeur.

The manufacturer assumes no responsibility for damage resulting from the non-application or incorrect application of the instructions provided herein.

El fabricante no se responsabiliza de los daños originados como resultado de la falta de aplicación o aplicación incorrecta de las presentes instrucciones.

O fabricante declinará toda e qualquer responsabilidade pelo resultado do não cumprimento das indicações constantes do presente manual de instruções.

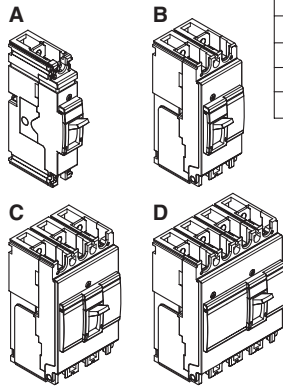
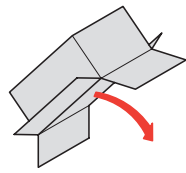

	1p	2p	3p	4p
A	X			
B		X		
C			X	
D				X
E	2	2	2	2
F	2	4	6	8
G	2	4	6	8
H	-	1	2	3
I	2	-	-	-
L	-	-	6	8

DRX (100A I_n, $\leq 125A$)



L

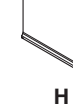
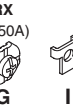
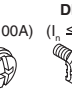
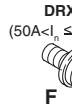
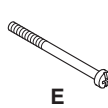

TEST

1

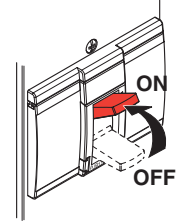

ON

OFF

2

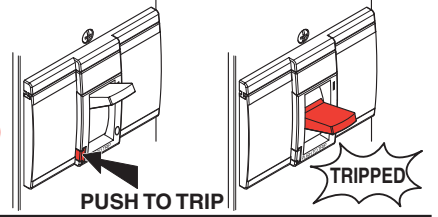

PUSH TO TRIP

TRIPPED

3

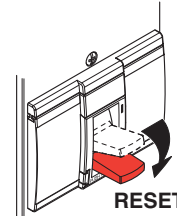

RESET

1-3-4 poles

2 poles

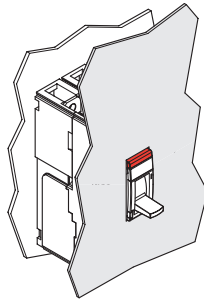
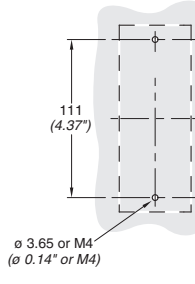
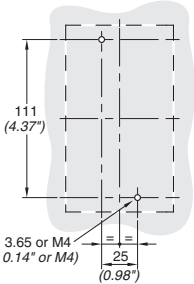

1-3-4 poles

2 poles

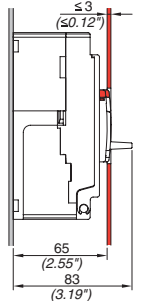
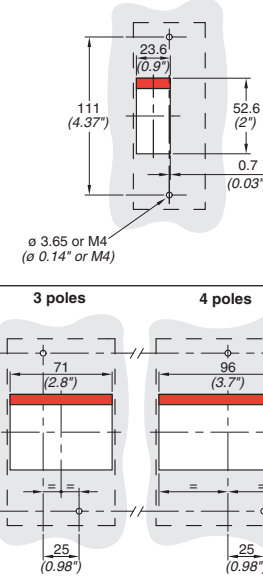
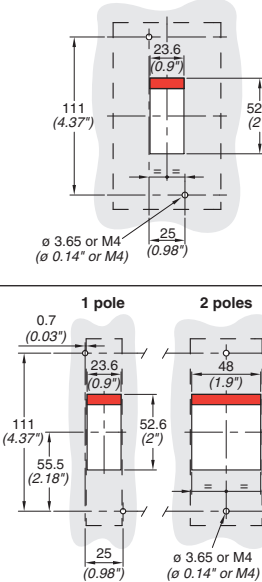

1 pole

1 Nm / 8.8 lb-in.

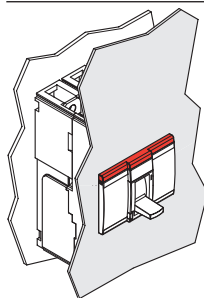
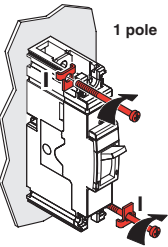

1 pole

2 poles

3 poles

4 poles

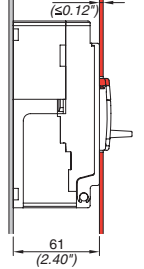
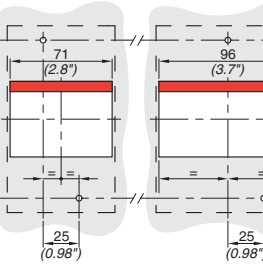
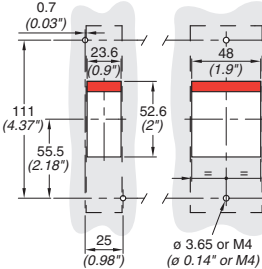

2 poles

3-4 poles

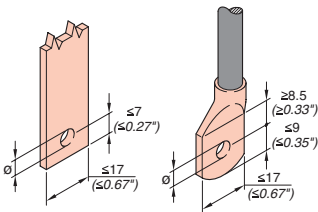
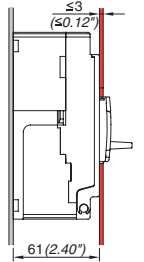
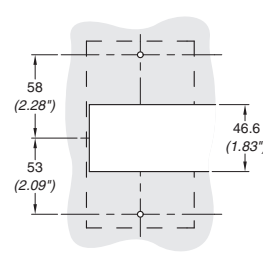
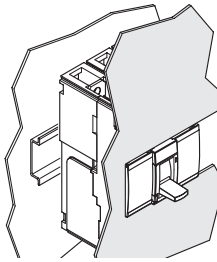
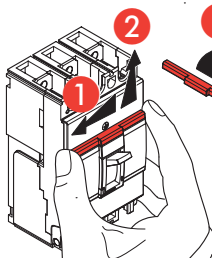
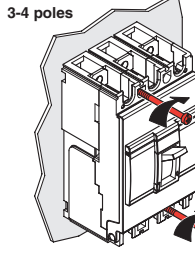
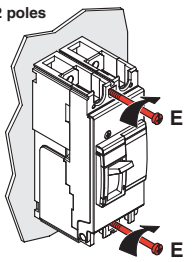

50A $\leq I_n$	50A I_n $\leq 125A$
\varnothing 5,5 / 0.21"	\varnothing 8,5 / 0.32"

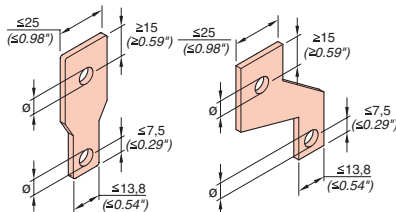

15A I_n $\leq 125A$
\varnothing 8,2 / 0.32"

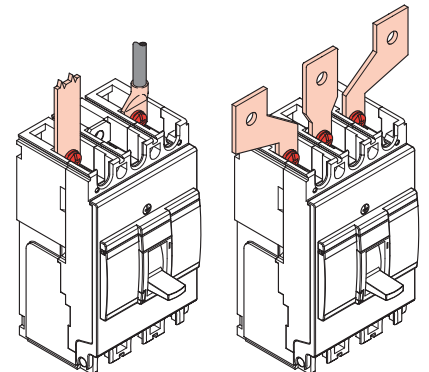

$I_n \leq 50A$	50A I_n $\leq 100A$	100A I_n $\leq 125A$
G	F	L

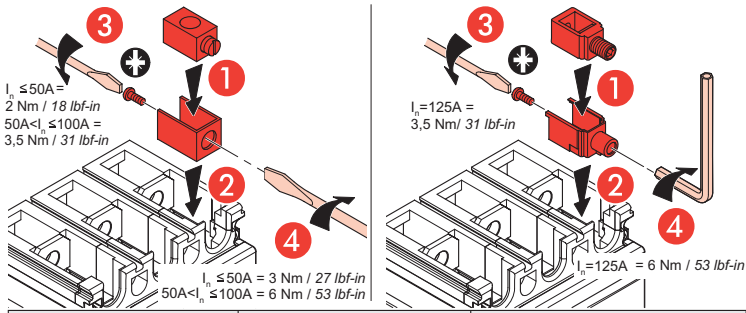

$I_n \leq 50A$	$50A < I_n \leq 100A$	$100A < I_n \leq 125A$
Flexible 2,5 → 10 mm ² #14 → #8 AWG or Solid 2,5 → 16 mm ² #14 → #6 AWG	Flexible 10 → 35 mm ² #8 → #3/2 AWG or Solid 10 → 50 mm ² #8 → #1/0 AWG	Flexible 35 → 50 mm ² #3/2 → #1/0 AWG or Solid 35 → 50 mm ² #3/2 → #1/0 AWG
2,5 to 4 mm ² #14 to #10 AWG flexible cables: connection via crimped end-barrels		

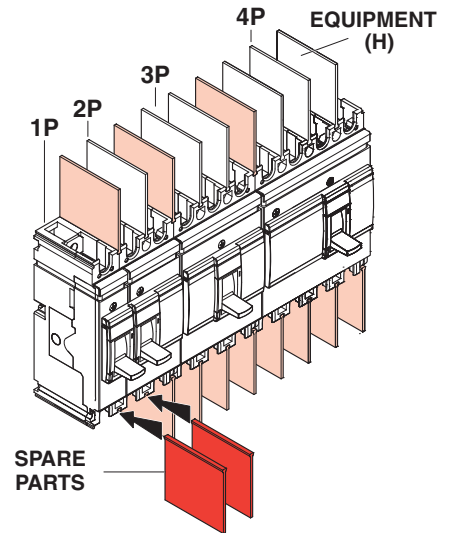

Consignes de sécurité

Ce produit doit être installé conformément aux règles d'installation et de préférence par un électricien qualifié. Une installation et une utilisation incorrectes peuvent entraîner des risques de choc électrique ou d'incendie. Avant d'effectuer l'installation, lire la notice, tenir compte du lieu de montage spécifique au produit. Ne pas ouvrir, démonter, altérer ou modifier l'appareil sauf mention particulière indiquée dans la notice. Tous les produits Legrand doivent exclusivement être ouverts et réparés par du personnel formé et habilité par Legrand. Toute ouverture ou réparation non autorisée annule l'intégralité des responsabilités, droits à remplacement et garanties. Utiliser exclusivement les accessoires de la marque Legrand.

FR BE CA LU CH



Safety instructions

This product should be installed in compliance with installation rules, preferably by a qualified electrician. Incorrect installation and use can lead to risk of electric shock or fire. Before carrying out the installation, read the instructions and take account of the product's specific mounting location. Do not open up, dismantle, alter or modify the device except where specifically required to do so by the instructions. All Legrand products must be opened and repaired exclusively by personnel trained and approved by Legrand. Any unauthorised opening or repair completely cancels all liabilities and the rights to replacement and guarantees. Use only Legrand brand accessories.

GB CA IN IE US



Consignas de seguridad

Este producto debe instalarse conforme a las normas de instalación y preferiblemente por un electricista cualificado. Una instalación y una utilización incorrectas pueden entrañar riesgos de choque eléctrico o de incendio. Antes de efectuar la instalación, leer las instrucciones, tener en cuenta el lugar de montaje específico del producto. No abrir, desmontar, alterar o modificar el aparato salvo que esto se indique específicamente en las instrucciones. Todos los productos Legrand deben ser abiertos y reparados exclusivamente por personal formado y habilitado por Legrand. Cualquier apertura o reparación no autorizada anula la totalidad de las responsabilidades, derechos a sustitución y garantías. Utilizar exclusivamente los accesorios de la marca Legrand.

ES CL CO CR MX PE US VE



Instruções de segurança

Este produto deve ser instalado de acordo com as regras de instalação e de preferência por um electricista qualificado. A instalação e o uso incorrectos podem provocar riscos de choque eléctrico ou de incêndio. Antes de efectuar a instalação, ler as instruções e ter em conta a localização adequada para a montagem do produto. Não abrir, desmontar, alterar ou modificar o aparelho salvo especificação em contrário nas instruções do produto. Todos os produtos Legrand só devem ser abertos e reparados exclusivamente por pessoal formado e autorizado pela Legrand. Qualquer abertura ou reparação não autorizada cancela todas as responsabilidades, direitos de substituição e garantias. Utilizar exclusivamente os acessórios da marca Legrand.

PT