

Part number

MHP 50.40

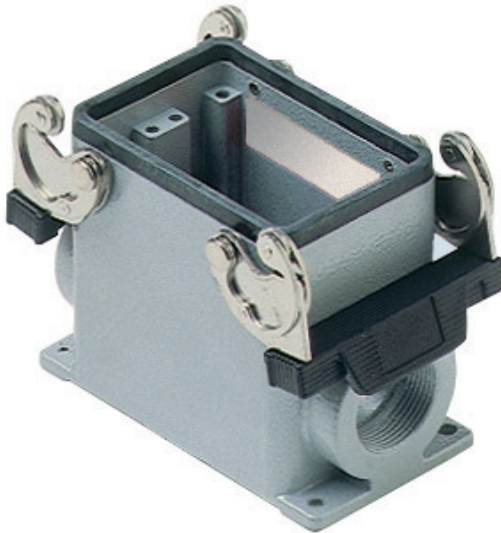

Surface mounting housing, C-TYPE series, with 2 levers, M40 cable entry, size "66.40"



Product description

Product type	Surface mounting housing
Series	C-TYPE
Closing type	With 2 levers
Size	Size "66.40"
Cable entry	With cable entry M40

Technical data

IP degree of protection IP65 / IP66 / IP69

Further technical details

Weight	442,00 g
Operating temperature range (min, max)	-40°C...+125°C

Material properties

Other materials	Lever: Stainless steel, polyamide (PA) Gasket: NBR
Colour	RAL 7040 grey
RoHs conformity	Compliant
China RoHs - EFUP	E
REACH SVHC substances	No

Approvals / Standards

Certifications	DNV, BV
UL	ECBT2
cUL	ECBT8

General ordering information

EAN13 code	8015747055291
eCl@ss 8.1	27440202
ETIM 7.0	EC000437

Packaging Information

Packaging length	350,00 mm
Packaging height	105,00 mm
Packaging width	145,00 mm
Packaging weight	2,35 kg
Packaging volume	5,33 dm ³
Packaging description	Carton box
Packaging quantity	5 Pcs
Packaging EAN code	8015747055307

Part number

MHP 50.40



Catalogue drawings

CHP - MHP



CHP CS - MHP CS

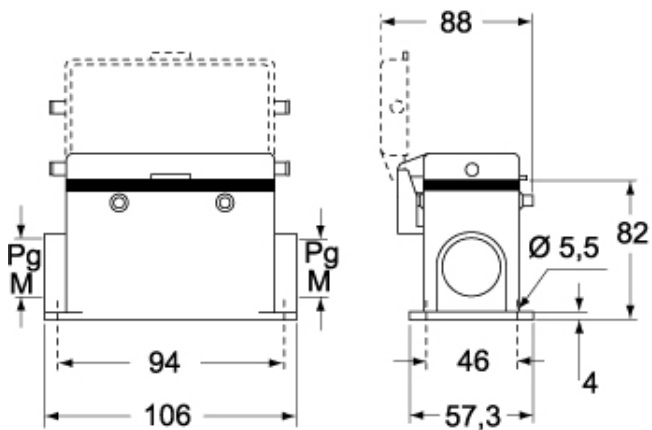

Catalogue drawings



Notes

Dimensions shown in mm are not binding and may be changed without notice.