

Suspension simple

Code: 22003171-00

INFORMATIONS GÉNÉRALES

Article	Suspension simple
Code	22003171-00

DIMENSIONS ET POIDS

Poids (Kg)	0.2 kg
------------	--------



Suspensão simples



Suspension simple

Code: 22003171-00

DONNÉES PHOTOMÉTRIQUES



Puissance absorbée (totale)
(W) 0 W

Suspension simple

Code: 22003171-00

MATÉRIAUX ET COULEURS

Corps	câble en acier (L = 1,5 m) avec dispositif de réglage millimétrique. Charge max. : 20 kg.
Couleur	Argent

NORMES ET CONFORMITÉ

Marquages et essais	CE
---------------------	----

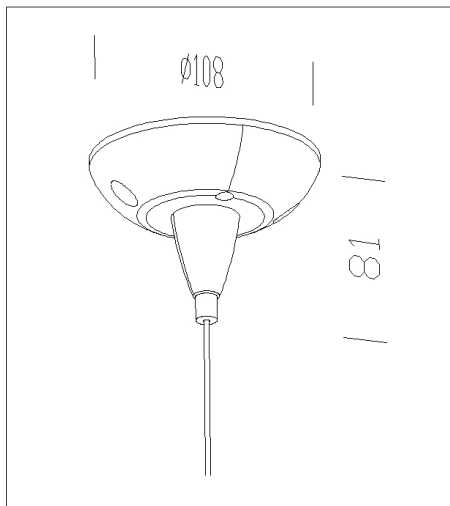

TÉLÉCHARGEMENT

DESSINS

DessinTechnique 3171.dxf



Suspension simple

Code: 22003171-00

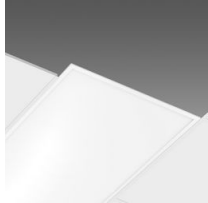

Eco Panel luminoso R4



Sintesi System - en suspension - extensif



Sintesi System - en suspension éclairage direct indirect - extensif



Sintesi System - en suspension éclairage direct indirect - optique basse luminance - UGR<19



Sintesi System - en suspension - avec diffuseur UGR<19



Sintesi System - en suspension - optique basse luminance - UGR<19



Sintesi System - en suspension avec diffuseur satiné - UGR<22



Sintesi System - en suspension éclairage direct indirect - extensif 60° - UGR<22



Sintesi System - en suspension éclairage direct indirect - avec diffuseur satiné - UGR<22



Sintesi System - en suspension éclairage direct indirect - avec diffuseur UGR<19

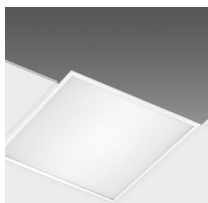

PanelTech HP A2 - UGR<19-22

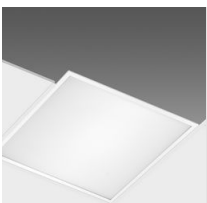

PanelTech A - UGR<19

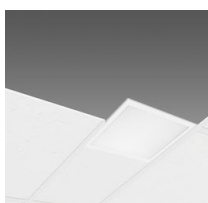

PanelTech B - UGR<19



PanelTech R3 - UGR<19

Suspension simple

Code: 22003171-00



PanelTech R2 - UGR<19



PanelTech HE A2 - UGR<19



PanelTech HE R2 - UGR<19



PanelTech HP R2 - UGR<19



PanelTech UGR<19 - A - DIP SWITCH



PanelTech R2 - UGR<19 - DIP SWITCH



PanelTech HE R2 - UGR<19 - DIP SWITCH



PanelTech HE A2 - UGR<19 - DIP SWITCH