

THIS COPY IS PROVIDED ON A RESTRICTED BASIS AND IS NOT TO BE USED IN ANY WAY DETRIMENTAL TO THE INTERESTS OF PANDUIT CORP.

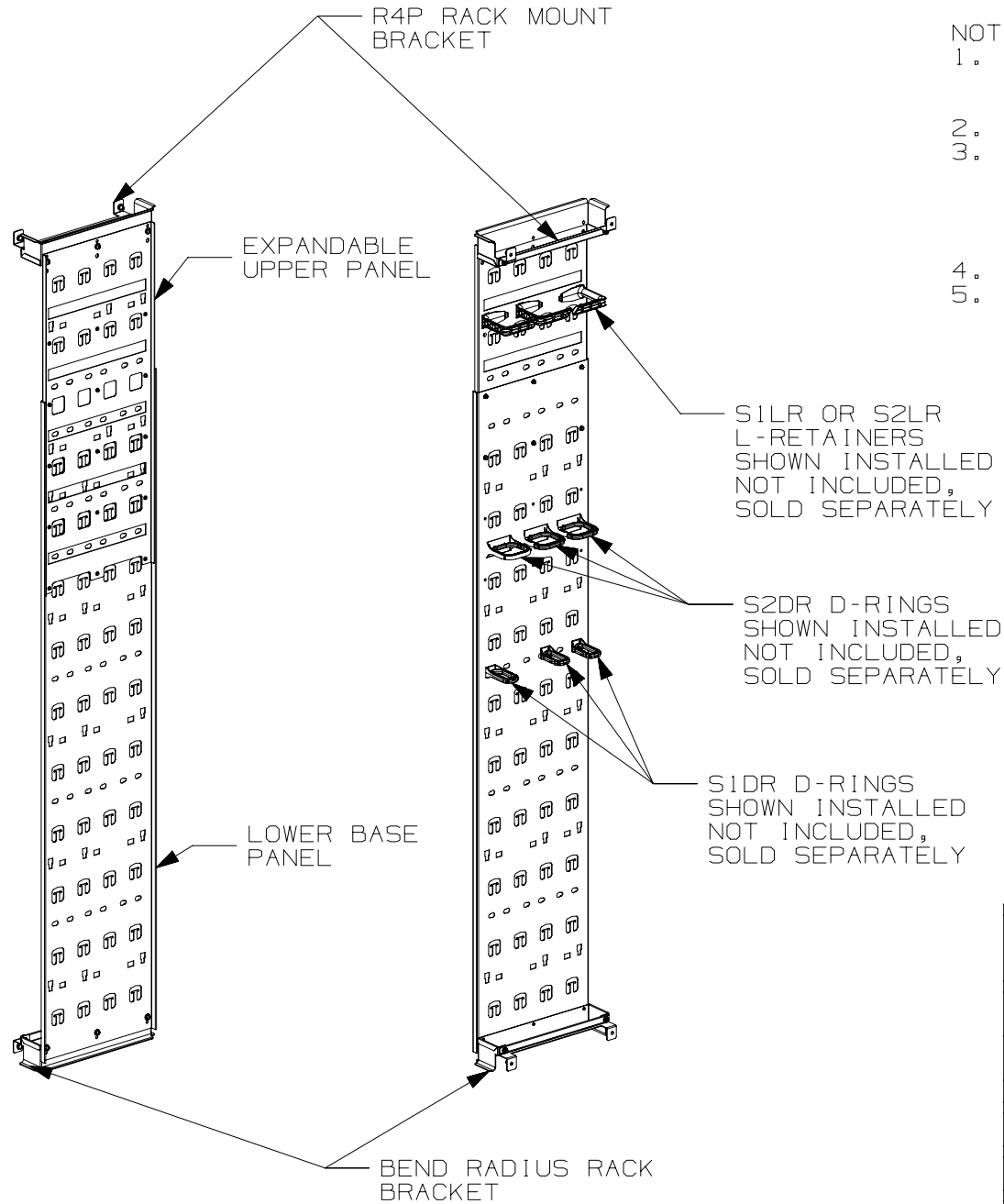

NOTES:

1. VISIT OUR ON-LINE CATALOG AT WWW.PANDUIT.COM FOR A LIST OF CURRENT PARTS APPLICABLE FOR USE WITH THIS PRODUCT.
2. DIMENSIONS IN [] ARE METRIC.
3. ALL MATERIALS AND COMPONENTS USED MEET THE MATERIAL RESTRICTIONS OF RoHS (EUROPEAN DIRECTIVE 2011/65/EU ON THE RESTRICTION OF HAZARDOUS SUBSTANCES) AS PROPOSED BY THE RoHS TECHNICAL ADAPTATION COMMITTEE.
4. WEIGHT: 25.2 LBS / 11.4 KG
5. PART INCLUDES:
 - (1) LOWER BASE PANEL
 - (1) EXPANDABLE UPPER PANEL
 - (2) BEND RADIUS MOUNT BRACKETS
 - (2) R4P RACK MOUNT BRACKETS
 - (1) HARDWARE KIT

PART NUMBER		V4PT0B / V4PT0BWH	
TITLE		VERTICAL 4 POST TIE OFF BRACKET	
ITEM REVISION NAME		CUSTOMER DRAWING	
DATASET FILE NAME		00448EAF-DC	
MATERIAL		STEEL	
DRAWING NUMBER		00448EAF-DC	
DRAWN BY		R7-28-20	
DATE		7-28-20	
CHK		KRKE	
SCALE		NONE	
SHEET 1 OF 4		A	

00B	11-11-20	RYB			UPDATED VIEWS	00448EAF-DC
00A	7-28-20	RYB	KRKE	JEFK	RELEASED TO PRODUCTION	M09000ME/01
REV	DATE	BY	CHK	APR	DESCRIPTION	ECN

2

1

2

1

A-SIZE CUSTOMER

B

B

A

A

THIS COPY IS PROVIDED ON A RESTRICTED BASIS AND IS NOT TO BE USED IN ANY WAY DETRIMENTAL TO THE INTERESTS OF PANDUIT CORP.

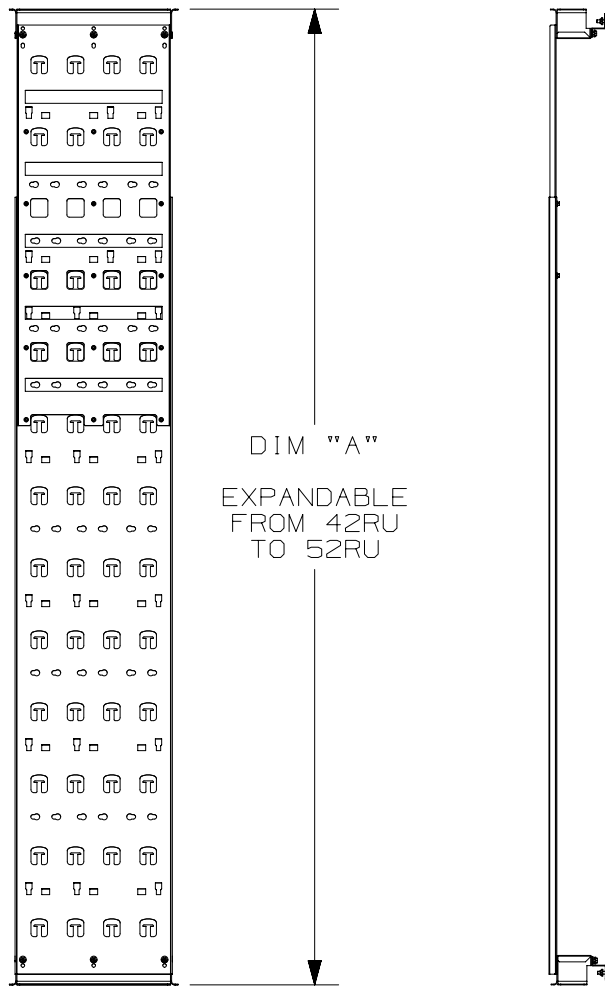
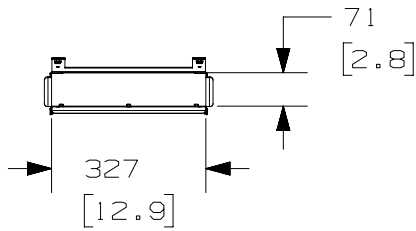

RACK STYLE	RACK HEIGHT	DIM "A" mm [inch]
AR4P	45RU	2065 [81.3]
	52RU	2370 [93.3]
R4P	42RU	1913 [75.3]
	45RU	2040 [80.3]
	52RU	2348 [92.4]

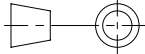
PART NUMBER		V4PT0B / V4PT0BWH	
TITLE		VERTICAL 4 POST TIE OFF BRACKET	
		CUSTOMER DRAWING	
ITEM REVISION NAME		00448EAF/00	
DATASET FILE NAME		00448EAF_DC_00B	
		THIRD ANGLE PROJECTION	
MATERIAL		STEEL	
DRAWING NUMBER		00448EAF - DC	
REV	DATE	BY	CHK
00B	11-11-20	RYB	
00A	7-28-20	RYB	KRKE
			JEFK
DESCRIPTION	ECN	DRAWING NUMBER	
SEE SHEET 1 OF 4	00448EAF-DC	SHEET 2 OF 4	
SEE SHEET 1 OF 4	M09000ME/01	SCALE	SIZE
		NONE	A

A-SIZE CUSTOMER

THIS COPY IS PROVIDED ON A RESTRICTED BASIS AND IS NOT TO BE USED IN ANY WAY DETRIMENTAL TO THE INTERESTS OF PANDUIT CORP.

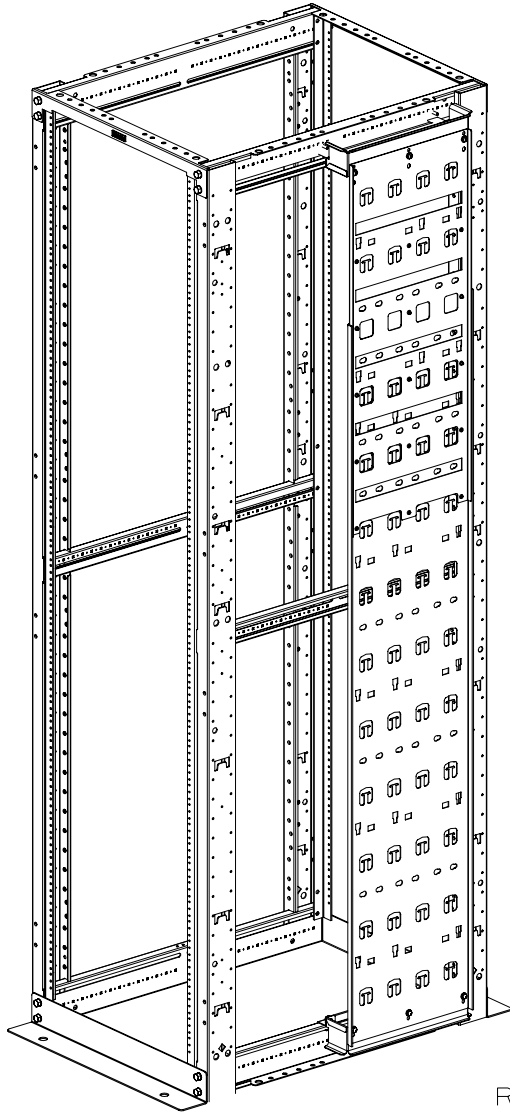

R4P RACK MOUNT

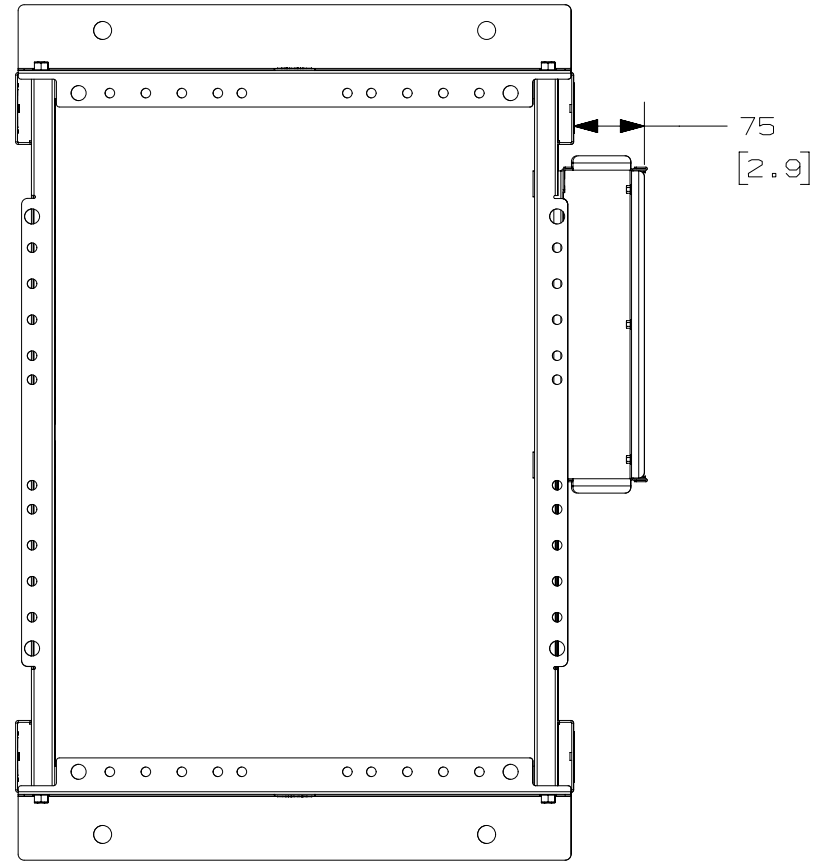

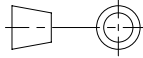
PART NUMBER		V4PTOB / V4PTOBWH	
TITLE		VERTICAL 4 POST TIE OFF BRACKET	
		CUSTOMER DRAWING	
ITEM REVISION NAME		00448EAF/00	
DATASET FILE NAME		00448EAF_DC_00B	
		THIRD ANGLE PROJECTION	
MATERIAL		STEEL	
DRAWING NUMBER		00448EAF - DC	
DRAWN BY	DATE	CHK	SCALE
RYB	7-28-20	KRKE	NONE
REV	DATE	BY	CHK
00B	11-11-20	RYB	
00A	7-28-20	RYB	KRKE
DESCRIPTION		ECN	
SEE SHEET 1 OF 4		00448EAF-DC	
SEE SHEET 1 OF 4		M09000ME/01	
SHEET 3 OF 4		A	

A-SIZE CUSTOMER

2

1

2

1

THIS COPY IS PROVIDED ON A RESTRICTED BASIS AND IS NOT TO BE USED IN ANY WAY DETRIMENTAL TO THE INTERESTS OF PANDUIT CORP.

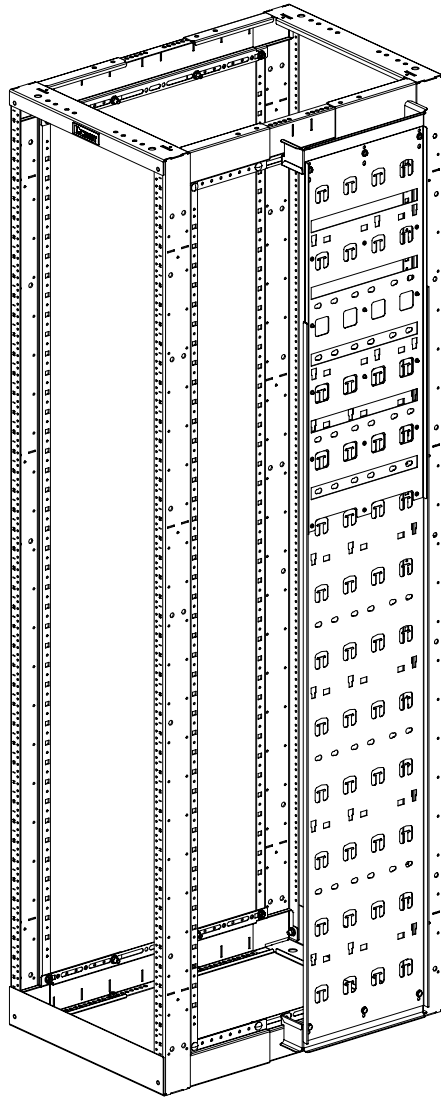

AR4P RACK MOUNT

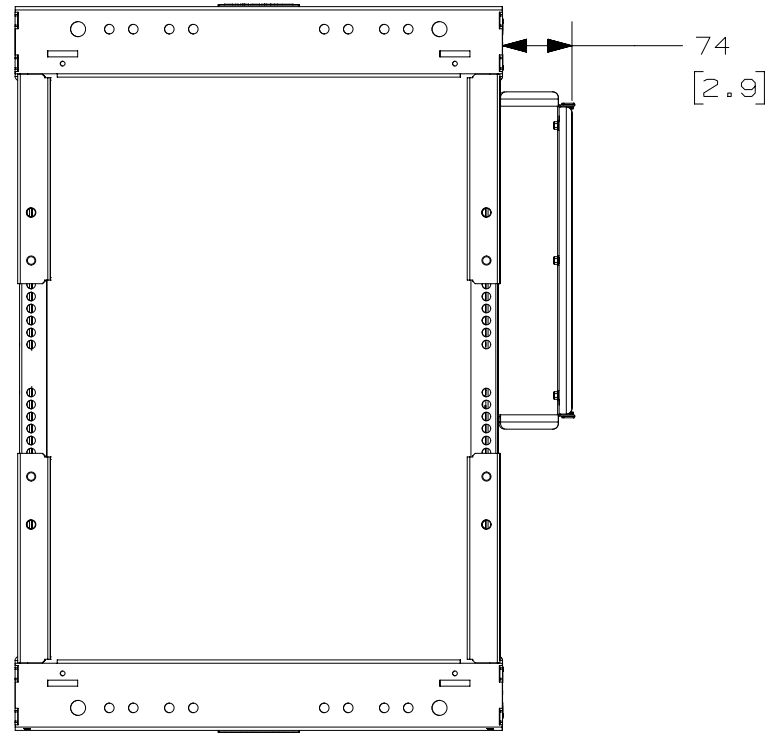

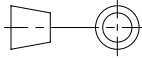
PART NUMBER		V4PT0B / V4PT0BWH	
TITLE		VERTICAL 4 POST TIE OFF BRACKET	
		CUSTOMER DRAWING	
ITEM REVISION NAME		00448EAF/00	
DATASET FILE NAME		00448EAF_DC_00B	
		THIRD ANGLE PROJECTION	
MATERIAL		STEEL	
DRAWING NUMBER		00448EAF - DC	
DRAWN BY	DATE	CHK	SCALE
RYB	7-28-20	KRKE	NONE
SHEET 4 OF 4		A	

REV	DATE	BY	CHK	APR	DESCRIPTION	ECN
00B	11-11-20	RYB			SEE SHEET 1 OF 4	00448EAF-DC
00A	7-28-20	RYB	KRKE	JEFK	SEE SHEET 1 OF 4	M09000ME/01

A-SIZE CUSTOMER

2

1

2

1