



Automatic mains failure gen-set controllers
RGK610

Product designation

Product type designation

Power supply

Rated battery voltage V 12/24VDC

Digital inputs

Digital input type 4 neg.+ 1 pos.

"W"/AC/PICK-UP speed inputs

"W"/AC/PICK-UP speed input type "W" or "Pick-up"

Voltage inputs

Rated voltage (Ue) VAC 100...480

Measurement range V 100...480

Frequency range Hz 45...65

Measurement method TRMS

Current inputs

Rated current (Ie) A 5A/1A

Measurement range 0.05...6A or 0.05...1.2A

Amperometric inputs type 3PH, /5A or /1A

Measurement method TRMS

Static Outputs

Static output type 6 (SSR)

Ambient conditions

Protection degree

IP40, IP65 with optional gasket seal

Dimensions

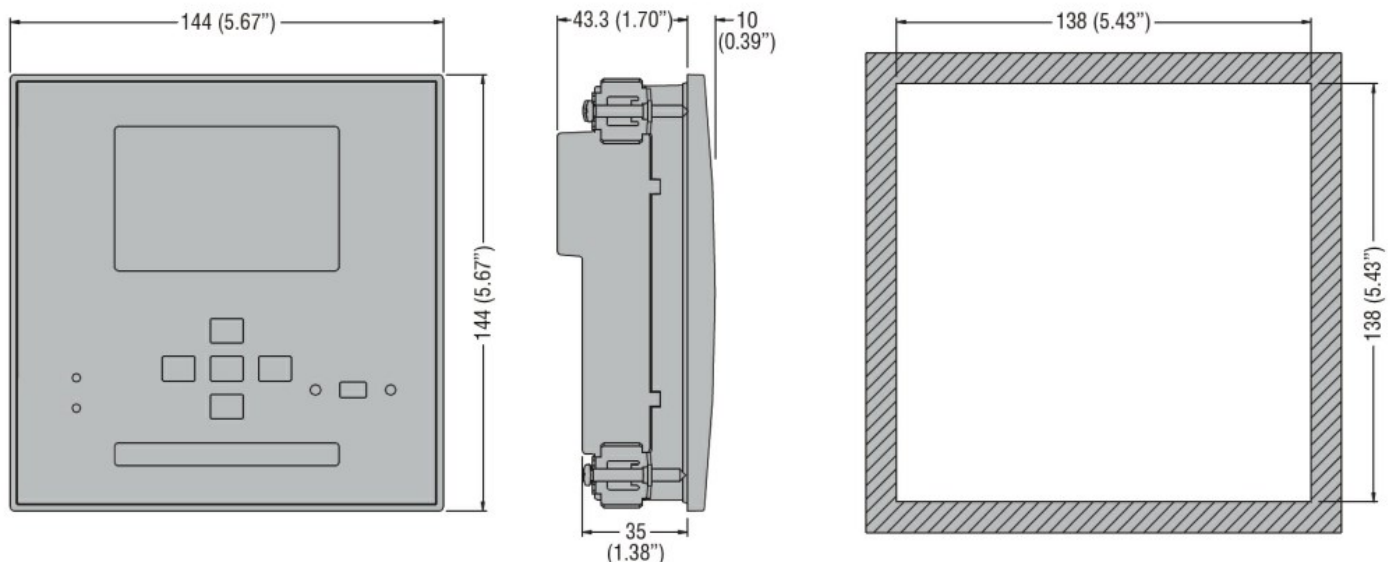

Wiring diagrams

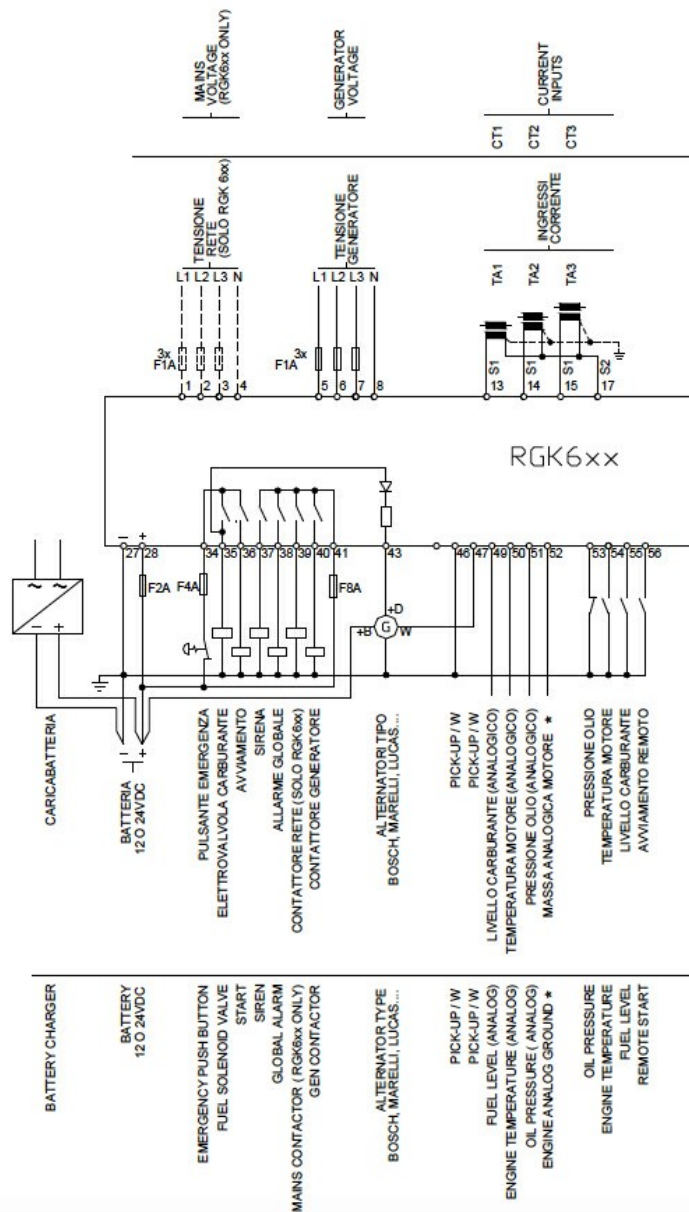

Certifications and compliance

Compliance

CSA C22.2 n° 14

IEC/EN 61000-6-2

IEC/EN 61000-6-3

IEC/EN 61010-1

UL 508

Certificates

EAC

UL Listed for USA and Canada (cULus-File E93601)

ETIM classification

ETIM 8.0

EC002758 -
Energy
management
controller