



# AFM60B-S1KA032768

AFS/AFM60 SSI

**ABSOLUTE ENCODERS**

**SICK**  
Sensor Intelligence.



Illustration may differ



### Ordering information

| Type              | Part no. |
|-------------------|----------|
| AFM60B-S1KA032768 | 1086237  |

Other models and accessories → [www.sick.com/AFS\\_AFM60\\_SSI](http://www.sick.com/AFS_AFM60_SSI)

### Detailed technical data

#### Performance

|   |                                  |
|---|----------------------------------|
| <b>Number of steps per revolution (max. resolution)</b>                         | 32,768 (15 bit)                  |
| <b>Number of revolutions</b>  | 4,096 (12 bit)                   |
| <b>Max. resolution (number of steps per revolution x number of revolutions)</b> | 15 bit x 12 bit (32,768 x 4,096) |
| <b>Error limits G</b>   | 0.05° <sup>1)</sup>              |
| <b>Repeatability standard deviation <math>\sigma_r</math></b>                   | 0.002° <sup>2)</sup>             |

<sup>1)</sup> In accordance with DIN ISO 1319-1, position of the upper and lower error limit depends on the installation situation, specified value refers to a symmetrical position, i.e. deviation in upper and lower direction is the same.

<sup>2)</sup> In accordance with DIN ISO 55350-13; 68.3% of the measured values are inside the specified area.

#### Interfaces

|  |  |
|--|--|
| <b>Communication interface</b>                 | SSI  |
| <b>Communication Interface detail</b>          | SSI + Sin/Cos  |
| <b>Initialization time</b>                     | 50 ms <sup>1)</sup>                                  |
| <b>Position forming time</b>                   | < 1 $\mu$ s  |
| <b>Code type</b>                               | Gray   |
| <b>Code sequence parameter adjustable</b>      | CW/CCW (V/R) parameter adjustable                    |
| <b>Clock frequency</b>                         | $\leq$ 2 MHz <sup>2)</sup>                           |
| <b>Set (electronic adjustment)</b>             | H-active (L = 0 - 3 V, H = 4,0 - U <sub>s</sub> V)   |
| <b>CW/CCW (counting sequence when turning)</b> | L-active (L = 0 - 1,5 V, H = 2,0 - U <sub>s</sub> V) |
| <b>Sine/cosine periods per revolution</b>      | 1,024  |
| <b>Output frequency</b>                        | $\leq$ 200 kHz                                       |
| <b>Load resistance</b>                         | $\geq$ 120 $\Omega$                                  |

<sup>1)</sup> Valid positional data can be read once this time has elapsed.

<sup>2)</sup> Minimum, LOW level (Clock +): 250 ns.

|   |                                     |
|---|-------------------------------------|
| <b>Signal before differential generation</b>        | 0.5 V <sub>pp</sub> , ± 20 %, 120 Ω |
| <b>Signal offset before differential generation</b> | 2.5 V ± 10 %                        |
| <b>Signal after differential generation</b>         | 1 V <sub>pp</sub> , ± 20 %          |

<sup>1)</sup> Valid positional data can be read once this time has elapsed.

<sup>2)</sup> Minimum, LOW level (Clock +): 250 ns.

## Electrical data

|  |  |
|--|--|
| <b>Connection type</b>                       | Male connector, M23, 12-pin, radial      |
| <b>Supply voltage</b>                        | 4.5 ... 32 V                             |
| <b>Power consumption</b>                     | ≤ 0.7 W (without load)                   |
| <b>Reverse polarity protection</b>           | ✓  |
| <b>MTTFd: mean time to dangerous failure</b> | 250 years (EN ISO 13849-1) <sup>1)</sup> |

<sup>1)</sup> This product is a standard product and does not constitute a safety component as defined in the Machinery Directive. Calculation based on nominal load of components, average ambient temperature 40 °C, frequency of use 8760 h/a. All electronic failures are considered hazardous. For more information, see document no. 8015532.

## Mechanical data

|                                       |   |
|---------------------------------------|---|
| <b>Mechanical design</b>              | Solid shaft, Servo flange               |
| <b>Shaft diameter</b>                 | 6 mm                                    |
| <b>Shaft length</b>                   | 10 mm                                   |
| <b>Weight</b>                         | 0.3 kg <sup>1)</sup>                    |
| <b>Shaft material</b>                 | Stainless steel                         |
| <b>Flange material</b>                | Aluminum                                |
| <b>Housing material</b>               | Aluminum die cast                       |
| <b>Start up torque</b>                | < 0.5 Ncm (+20 °C)                      |
| <b>Operating torque</b>               | < 0.3 Ncm (+20 °C)                      |
| <b>Permissible shaft loading</b>      | 80 N (radial)<br>40 N (axial)           |
| <b>Operating speed</b>                | ≤ 9,000 min <sup>-1</sup> <sup>2)</sup> |
| <b>Moment of inertia of the rotor</b> | 6.2 gcm <sup>2</sup>                    |
| <b>Bearing lifetime</b>               | 3.0 x 10 <sup>9</sup> revolutions       |
| <b>Angular acceleration</b>           | ≤ 500,000 rad/s <sup>2</sup>            |

<sup>1)</sup> Based on devices with male connector.

<sup>2)</sup> Allow for self-heating of 3.3 K per 1,000 rpm when designing the operating temperature range.

## Ambient data

|                                      |  |
|--------------------------------------|--|
| <b>EMC</b>                           | According to EN 61000-6-2 and EN 61000-6-3 <sup>1)</sup>                     |
| <b>Enclosure rating</b>              | IP65, shaft side (IEC 60529)<br>IP67, housing side (IEC 60529) <sup>2)</sup> |
| <b>Permissible relative humidity</b> | 90 % (Condensation not permitted)  |
| <b>Operating temperature range</b>   | -40 °C ... +100 °C <sup>3)</sup>   |
| <b>Storage temperature range</b>     | -40 °C ... +100 °C, without package  |

<sup>1)</sup> EMC according to the standards quoted is achieved if shielded cables are used.

<sup>2)</sup> For devices with male connector: with mounted mating connector.

<sup>3)</sup> Stationary position of the cable.

|                                |   |
|--------------------------------|---|
| <b>Resistance to shocks</b>    | 70 g, 6 ms (EN 60068-2-27)              |
| <b>Resistance to vibration</b> | 30 g, 10 Hz ... 2,000 Hz (EN 60068-2-6) |

1) EMC according to the standards quoted is achieved if shielded cables are used.

2) For devices with male connector: with mounted mating connector.

3) Stationary position of the cable.

### Classifications

|                       |          |
|-----------------------|----------|
| <b>eCl@ss 5.0</b>     | 27270502 |
| <b>eCl@ss 5.1.4</b>   | 27270502 |
| <b>eCl@ss 6.0</b>     | 27270590 |
| <b>eCl@ss 6.2</b>     | 27270590 |
| <b>eCl@ss 7.0</b>     | 27270502 |
| <b>eCl@ss 8.0</b>     | 27270502 |
| <b>eCl@ss 8.1</b>     | 27270502 |
| <b>eCl@ss 9.0</b>     | 27270502 |
| <b>eCl@ss 10.0</b>    | 27270502 |
| <b>eCl@ss 11.0</b>    | 27270502 |
| <b>eCl@ss 12.0</b>    | 27270502 |
| <b>ETIM 5.0</b>       | EC001486 |
| <b>ETIM 6.0</b>       | EC001486 |
| <b>ETIM 7.0</b>       | EC001486 |
| <b>ETIM 8.0</b>       | EC001486 |
| <b>UNSPSC 16.0901</b> | 41112113 |

### Dimensional drawing (Dimensions in mm (inch))

Servo flange, M12 and M23 radial male connector

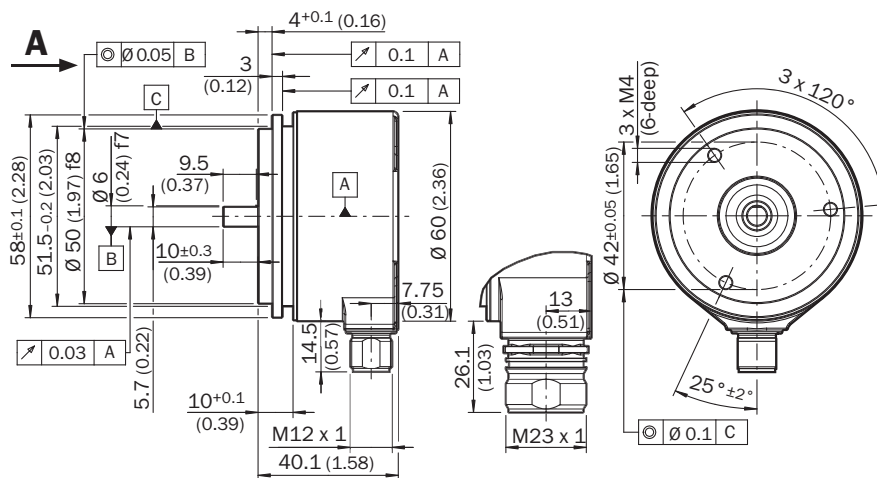

General tolerances according to DIN ISO 2768-mk

Attachment specifications

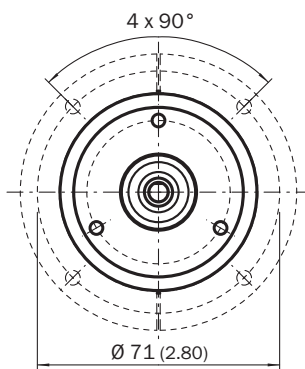
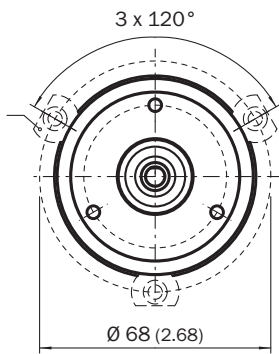

PIN assignment

M23 male connector, 12-pin and cable, 12-wire, SSI/Gray + SIN/COS

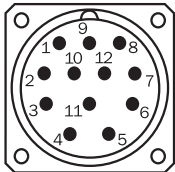

View of M23 male device connector on encoder

| PIN | Wire colors (cable connection) | Signal Incremental | Explanation                       |
|-----|--------------------------------|--------------------|-----------------------------------|
| 1   | Red                            | U <sub>S</sub>     | Operating voltage                 |
| 2   | Blue                           | GND                | Ground connection                 |
| 3   | Yellow                         | Clock +            | Interface signals                 |
| 4   | White                          | Data +             | Interface signals                 |
| 5   | Orange                         | SET                | Electronic adjustment             |
| 6   | Brown                          | Data -             | Interface signals                 |
| 7   | Violet                         | Clock -            | Interface signals                 |
| 8   | Black                          | - SIN              | Signal wire                       |
| 9   | Orange-black                   | CW/CCW (V/R)       | Sequence in direction of rotation |
| 10  | Green                          | - COS              | Signal wire                       |
| 11  | Gray                           | + COS              | Signal wire                       |

| PIN | Wire colors (cable connection) | Signal Incremental | Explanation   |
|-----|--------------------------------|--------------------|---|
| 12  | Pink                           | + SIN              | Signal wire   |
|     |                                | Screen             | Screen connected to housing on encoder side. Connected to ground on control side. |

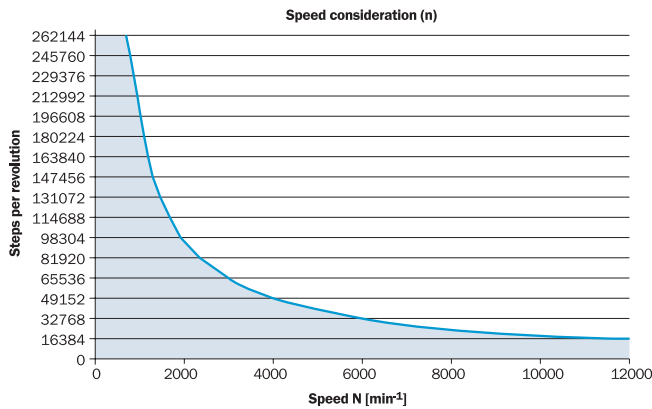

### Diagrams











The maximum speed is also dependent on the shaft type.

### Recommended accessories

Other models and accessories → [www.sick.com/AFS\\_AFM60\\_SSI](http://www.sick.com/AFS_AFM60_SSI)

|   | Brief description   | Type             | Part no. |
|---|---|------------------|----------|
| <b>Other mounting accessories</b>   |   |                  |          |
|  | Servo clamps, large, for servo flange (clamps, eccentric fastener), 3 pcs, without mounting material, without mounting hardware | BEF-WK-SF        | 2029166  |
| <b>Plug connectors and cables</b>   |   |                  |          |
|  | Head A: female connector, M23, 12-pin, straight<br>Head B: Flying leads<br>Cable: shielded, 3 m                                 | DOL-2312-G03MMD2 | 2062300  |
|   | Head A: female connector, M23, 12-pin, straight<br>Head B: Flying leads<br>Cable: shielded, 5 m                                 | DOL-2312-G05MMD2 | 2062301  |
|   | Head A: female connector, M23, 12-pin, straight<br>Head B: Flying leads<br>Cable: shielded, 10 m                                | DOL-2312-G10MMD2 | 2062302  |
|   | Head A: female connector, M23, 12-pin, straight<br>Head B: Flying leads<br>Cable: unshielded, 1.5 m                             | DOL-2312-G1M5MD2 | 2062284  |
|   | Head A: female connector, M23, 12-pin, straight<br>Head B: Flying leads<br>Cable: shielded, 20 m                                | DOL-2312-G20MMD2 | 2062303  |

|   | Brief description  | Type                       | Part no.           |
|---|--|----------------------------|--------------------|
|    | Head A: female connector, M23, 12-pin, straight<br>Head B: Flying leads<br>Cable: shielded, 30 m   | DOL-2312-G30MMD2           | 2062304            |
|   | Head A: female connector, M23, 9-pin, straight<br>Cable: HIPERFACE <sup>®</sup> , SSI, Incremental, shielded   | DOS-2309-G                 | 6028533            |
|   | Head A: female connector, M23, 12-pin, straight<br>Cable: HIPERFACE <sup>®</sup> , SSI, Incremental, shielded  | DOS-2312-G<br>DOS-2312-G02 | 6027538<br>2077057 |
|    | Head A: female connector, M23, 12-pin, angled<br>Cable: HIPERFACE <sup>®</sup> , SSI, Incremental, shielded  | DOS-2312-W01               | 2072580            |
| <b>Shaft adaptation</b>   |  |                            |                    |
|    | Bellows coupling, shaft diameter 6 mm / 6 mm, maximum shaft offset: radial ± 0.25 mm, axial ± 0.4 mm, angular +/- 4°; max. speed 10,000 rpm, -30 °C to +120 °C, max. torque 120 Ncm; material: stainless steel bellows, aluminum hub   | KUP-0606-B                 | 5312981            |
|    | Cross-slotted coupling, shaft diameter 6 mm / 6 mm, maximum shaft offset: radial ± 0.3 mm, axial ± 0.2 mm, angle ± 3°; max. speed 10,000 rpm, -10° to +80 °C, max. torque 80 Ncm; material: fiber-glass reinforced polyamide, aluminum hub   | KUP-0606-S                 | 2056406            |
|   | Bar coupling, shaft diameter 6 mm / 8 mm, maximum shaft offset radial ± 0.3 mm, axial ± 0.2 mm, angle ± 3°, max. speed 10,000 rpm, torsion spring rigidity 38 Nm/wheel; material: fiber-glass reinforced polyamide, aluminum hub   | KUP-0608-S                 | 5314179            |
|    | Bellows coupling, shaft diameter 6 mm / 10 mm, maximum shaft offset: radial ± 0.25 mm, axial ± 0.4 mm, angular +/- 4°; max. speed 10,000 rpm, -30 °C to +120 °C, max. torque 120 Ncm; material: stainless steel bellows, aluminum hub  | KUP-0610-B                 | 5312982            |
|   | Double loop coupling, shaft diameter 6 mm / 10 mm, max. shaft offset: radially +/- 2,5 mm, axially +/- 3 mm, angle +/- 10 degrees; max. speed 3.000 rpm, -30 to +80 degrees Celsius, torsional spring stiffness of 25 Nm/rad   | KUP-0610-D                 | 5326697            |
|  | Spring washer coupling, shaft diameter 6 mm / 10 mm, Maximum shaft offset: radial +/- 0.3 mm, axial +/- 0.4 mm, angular +/- 2.5°; max. speed 12,000 rpm, -10° to +80 °C, max. torque 60 Ncm; material: aluminum flange, glass fiber-reinforced polyamide membrane and hardened steel coupling pin  | KUP-0610-F                 | 5312985            |
|  | Claw coupling, shaft diameter 6 mm / 10 mm, damping element 80 shore blue, maximum shaft offset: radial ± 0.22 mm, axial ± 1 mm angular ± 1.3°, max. speed 19,000 rpm, angle of twist max. 10°, -30 °C to +80 °C, max. torque 800 Ncm, tightening torque of screws: ISO 4029 150 Ncm, material: aluminum flange, damping element: polyurethane | KUP-0610-J                 | 2127056            |
|  | Bar coupling, shaft diameter 6 mm / 10 mm, max. shaft offset: radial ± 0,3 mm, axial ± 0,3 mm, angular ± 3°; max. speed 10.000 rpm, -10° to +80 °C, max. torque: 80 Ncm, material: fiber-glass reinforced polyamide, aluminum hub  | KUP-0610-S                 | 2056407            |

## SICK AT A GLANCE

SICK is one of the leading manufacturers of intelligent sensors and sensor solutions for industrial applications. A unique range of products and services creates the perfect basis for controlling processes securely and efficiently, protecting individuals from accidents and preventing damage to the environment.

We have extensive experience in a wide range of industries and understand their processes and requirements. With intelligent sensors, we can deliver exactly what our customers need. In application centers in Europe, Asia and North America, system solutions are tested and optimized in accordance with customer specifications. All this makes us a reliable supplier and development partner.

Comprehensive services complete our offering: SICK LifeTime Services provide support throughout the machine life cycle and ensure safety and productivity.

For us, that is “Sensor Intelligence.”

## WORLDWIDE PRESENCE:

Contacts and other locations –[www.sick.com](http://www.sick.com)