



# LUT9U-11316

## LUT9

LUMINESCENCE SENSORS

**SICK**  
Sensor Intelligence.



Illustration may differ



## Ordering information

Type	Part no.
LUT9U-11316	1047052

Other models and accessories → [www.sick.com/LUT9](http://www.sick.com/LUT9)

## Detailed technical data

### Features

<b>Dimensions (W x H x D)</b>	30.4 mm x 53 mm x 80 mm
<b>Sensing distance</b>	50 mm <sup>1)</sup>
<b>Housing design</b>	Large
<b>Working range</b>	20 mm ... 70 mm
<b>Light source</b>	LED, UV <sup>2)</sup>
<b>Wave length</b>	375 nm
<b>Light emission</b>	Long side
<b>Light spot size</b>	5 mm x 15 mm
<b>Light spot direction</b>	Vertical
<b>Receiving filters</b>	OG 570
<b>Receiving range</b>	570 nm ... 750 nm
<b>Adjustment</b>	Teach-in button
<b>Teach-in mode</b>	Static 2-point teach-in with manual fine adjustment
<b>Output function</b>	Light switching <sup>3)</sup>

<sup>1)</sup> From leading edge of lens.

<sup>2)</sup> Average service life: 100,000 h at T<sub>U</sub> = +25 °C.

<sup>3)</sup> L/D switching via teach-in.

### Mechanics/electronics

<b>Supply voltage</b>	10 V DC ... 30 V DC <sup>1)</sup>
<b>Ripple</b>	< 5 V <sub>pp</sub> <sup>2)</sup>

<sup>1)</sup> Limit values when operated in short-circuit protected network: max. 8 A.

<sup>2)</sup> May not exceed or fall below U<sub>V</sub> tolerances.

<sup>3)</sup> Without load.

<sup>4)</sup> With light/dark ratio 1:1, without timer stage.

<sup>5)</sup> Signal transit time with resistive load.

<sup>6)</sup> Reference voltage DC 50 V.

<b>Current consumption</b>	< 100 mA <sup>3)</sup>
<b>Switching frequency</b>	0.5 kHz <sup>4)</sup> 2.5 kHz 6.5 kHz Adjustable
<b>Response time</b>	1 ms, 200 µs, 75 µs <sup>5)</sup>
<b>Switching output</b>	PNP, NPN
<b>Switching output (voltage)</b>	PNP: HIGH = $U_V \leq 2\text{ V}$ / LOW approx. 0 V NPN: HIGH = approx. $U_V$ / LOW $\leq 2\text{ V}$
<b>Switching mode</b>	Light switching
<b>Analog output</b>	0 mA ... 13 mA
<b>Output current <math>I_{\text{max}}</math></b>	100 mA
<b>Time delay</b>	Switch-off delay, 0 ms / 10 ms / 20 ms, adjustable (0 ms = default)
<b>Connection type</b>	Male connector M12, 5-pin
<b>Protection class</b>	II <sup>6)</sup>
<b>Circuit protection</b>	$U_V$ connections, reverse polarity protected Output Q short-circuit protected Interference pulse suppression
<b>Enclosure rating</b>	IP67
<b>Weight</b>	400 g
<b>Housing material</b>	Metal, zinc diecast

1) Limit values when operated in short-circuit protected network: max. 8 A.

2) May not exceed or fall below  $U_V$  tolerances.

3) Without load.

4) With light/dark ratio 1:1, without timer stage.

5) Signal transit time with resistive load.

6) Reference voltage DC 50 V.

## Ambient data

<b>Ambient operating temperature</b>	-10 °C ... +55 °C
<b>Ambient temperature, storage</b>	-25 °C ... +75 °C
<b>Shock load</b>	According to IEC 60068

## Classifications

<b>ECLASS 5.0</b>	27270908
<b>ECLASS 5.1.4</b>	27270908
<b>ECLASS 6.0</b>	27270908
<b>ECLASS 6.2</b>	27270908
<b>ECLASS 7.0</b>	27270908
<b>ECLASS 8.0</b>	27270908
<b>ECLASS 8.1</b>	27270908
<b>ECLASS 9.0</b>	27270908
<b>ECLASS 10.0</b>	27270908
<b>ECLASS 11.0</b>	27270908
<b>ECLASS 12.0</b>	27270908
<b>ETIM 5.0</b>	EC001822

<b>ETIM 6.0</b>	EC001822
<b>ETIM 7.0</b>	EC001822
<b>ETIM 8.0</b>	EC001822
<b>UNSPSC 16.0901</b>	39121528

### Dimensional drawing (Dimensions in mm (inch))

LUT9x-x1xxx, light Emission: Long side

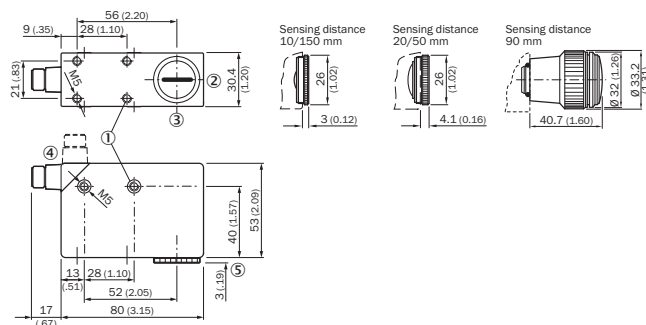

- ① M5 threaded mounting hole, 5.5 mm deep
- ② Lens (light transmission), can be replaced by blind screw
- ③ Center of optical axis
- ④ Connector M12 (rotatable up to 90°)
- ⑤ See dimensional drawings of lenses
- ⑥ Blind screw can be replaced by lens

### Adjustments

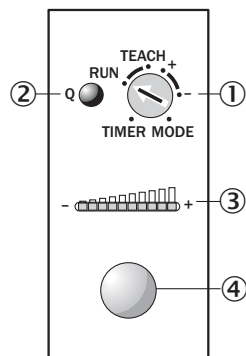

- ① Rotary selection switch
- ② Function signal indicator (yellow), switching output
- ③ Bar graph (green), power-on left-hand LED
- ④ Teach-in button

## Connection diagram

Cd-312

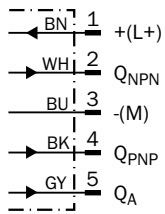

## Concept of operation

Teach-in static

### 1. Position mark

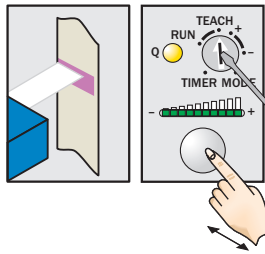

Turn rotary switch to "TEACH" position and press and hold teach-in button > 1 s. Yellow LED flashes slowly.

### 2. Position background

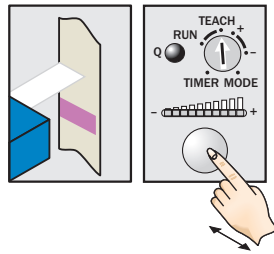

Press and hold teach-in button again > 1 s. Yellow LED goes out.

### Sensitivity setting

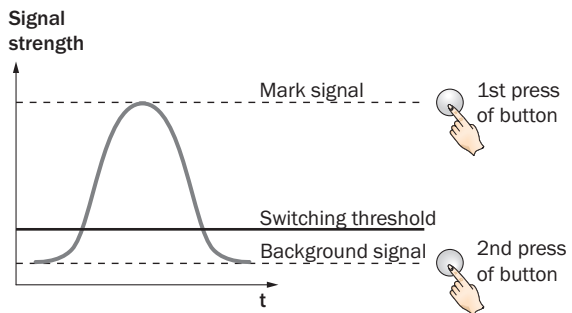

### Note

The bar graph display shows detection reliability. The more LEDs that illuminate, the better the teach-in.

Button +/-

**1. Position mark**

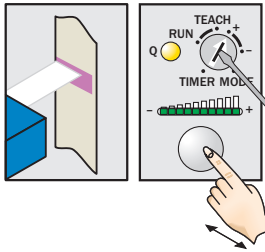

Turn rotary switch to “+” position and press and hold teach-in button until yellow light goes out (more green LEDs illuminate on the bar display).

**2. Position background**

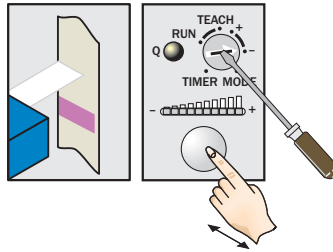

If yellow LED illuminates, turn rotary switch to “-” position and press and hold teach-in button until yellow light just goes out (green LEDs go out on the bar display).

**Sensitivity setting**

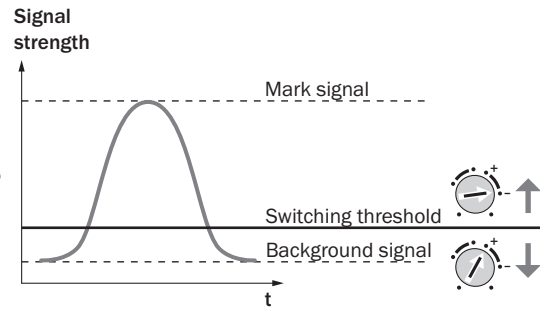

**Note for all settings**

Once configuration is complete, turn the rotary switch to the “RUN” position. The bar display then shows the luminescence intensity (regardless of switching threshold setting).

Adjustments are intended for luminescence background suppression.

**Sensing distance**

Sensing distance

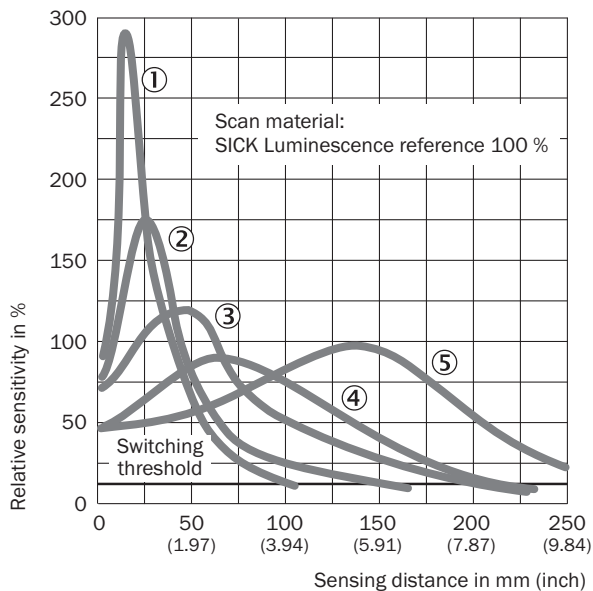

- ① Sensing distance 10 mm
- ② Sensing distance 20 mm
- ③ Sensing distance 50 mm
- ④ Sensing distance 90 mm
- ⑤ Sensing distance 150 mm

## Light spot size

Light spot size

### Sensing distance 10 mm

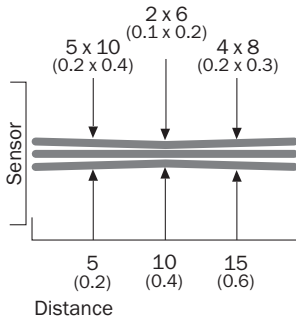

### Sensing distance 20 mm

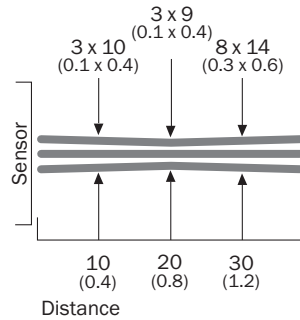

### Sensing distance 50 mm

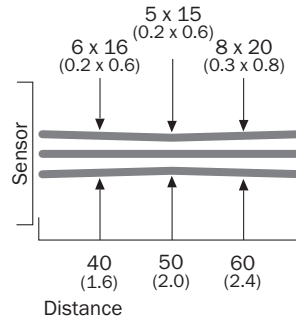

### Sensing distance 90 mm

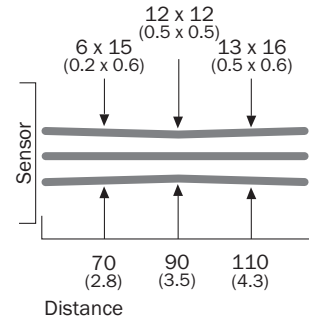

### Sensing distance 150 mm

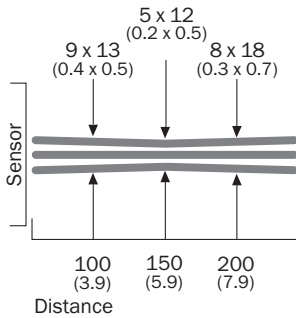













All dimensions in mm (inch)

## Recommended accessories

Other models and accessories → [www.sick.com/LUT9](http://www.sick.com/LUT9)

	Brief description	Type	Part no.
<b>Lenses and accessories</b>			
	Lens, 90 mm scanning distance, M20 x 0.75	OBJ-026	1001326
	Lens, 10 mm sensing distance, M25 x 0.75	OBJ-LUT3-10	2016348
	Lens, 20 mm sensing distance, M25 x 0.75	OBJ-LUT3-20	2016349
	Lens, 50 mm sensing distance, M25 x 0.75	OBJ-LUT3-50	2016350
<b>Universal bar clamp systems</b>			
		BEF-KHS-G01	2022464
		BEF-KHS-K01	2022718

	Brief description	Type	Part no.
		BEF-KHS-KH1	2022726
		BEF-MS12G-A	4056054
		BEF-MS12G-B	4056055
		BEF-MS12L-A	4056052
		BEF-MS12L-B	4056053
Plug connectors and cables			
		YF2A15-020VB5XLEAX	2096239
		YF2A15-050VB5XLEAX	2096240
		YF2A15-100VB5XLEAX	2096241
		YG2A15-020VB5XLEAX	2096215
		YG2A15-050VB5XLEAX	2096216
		YG2A15-100VB5XLEAX	2096217
		DOS-1205-G	6009719
		DOS-1205-W	6009720



## SICK AT A GLANCE

SICK is one of the leading manufacturers of intelligent sensors and sensor solutions for industrial applications. A unique range of products and services creates the perfect basis for controlling processes securely and efficiently, protecting individuals from accidents and preventing damage to the environment.

We have extensive experience in a wide range of industries and understand their processes and requirements. With intelligent sensors, we can deliver exactly what our customers need. In application centers in Europe, Asia and North America, system solutions are tested and optimized in accordance with customer specifications. All this makes us a reliable supplier and development partner.

Comprehensive services complete our offering: SICK LifeTime Services provide support throughout the machine life cycle and ensure safety and productivity.

For us, that is “Sensor Intelligence.”

## WORLDWIDE PRESENCE:

Contacts and other locations –[www.sick.com](http://www.sick.com)