



Product designation

Signal tower
Ø50mm/1.97"

Product type designation

LTN50

General characteristics

Diameter mm - inch 50 / 1.97

Material Plastic

Mechanical features

Weight g 32

Ambient conditions

Temperature

Operating temperature

min	°C	-30
max	°C	+50

Dimensions

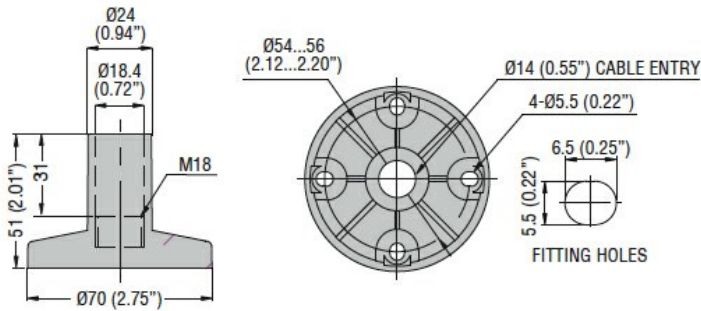

Certifications and compliance

Compliance

IEC/EN/BS 60947-1
IEC/EN/BS 60947-5-1

ETIM classification

ETIM 8.0

EC001153 - Wall
bracket for signal
tower