



Product designation	Hinge operating		
Product type designation	KBP		
General characteristics			
General characteristics			
Housing Material	Polymer thermoplastic		
Rod material	Long solid		
Contact characteristics			
Type of contact	1NO+2NC Slow action		
Thermal current I _{th}	A	10	
IEC/EN 60947-5-1 designation	A600 Q300		
Rated insulation voltage U _i	V	690	
Rated impulse withstand voltage U _{imp}	kV	6	
Insulation class	II		
Short-circuit protection with fuse	Class/A	10 gG/SC QUICK FUSE	
Switching speed	min	m/s	0.5
	max	m/s	1.5
IEC Conventional free air thermal current I _{th}	A	10	
Resistance per pole (average value)	mΩ	<10	
Operations			
Mechanical life	cycles	100000	
B10d	cycles	100000	
Mechanical operation	cycles/h	3600	
Output characteristics			
Mechanical life	cycles	100000	
Mechanical features			
Operating head fixing	Locking bayonet insert		
Operating torque	Ncm	15	
	ozin	21.2	
Tightening torque (Max)			
Switch fixing	Nm	2.5	
	lbin	22.1	
Contact terminals	Nm	0.8	
	lbin	7	
Body lid screw fixing	Nm	0.8	
	lbin	7	
Conductor section			

LIMIT SWITCH, K SERIES, HINGE OPERATING, 1 BOTTOM CABLE ENTRY. DIMENSIONS TO EN 50047, PLASTIC BODY, CONTACTS 1NO+2NC SLOW ACTION. LONG SOLID SHAFT

AWG/Kcmil

min	16
max	14

IEC

min	mm ²	1 or 2
max	mm ²	2.5

Cable connection

Self-releasing screw terminal

Cable entry

M20 on the bottom

Ambient conditions

Pollution degree

3

Temperature

Operating temperature

min	°C	-25
max	°C	+70

Storage temperature

min	°C	-40
max	°C	+70

Dimensions

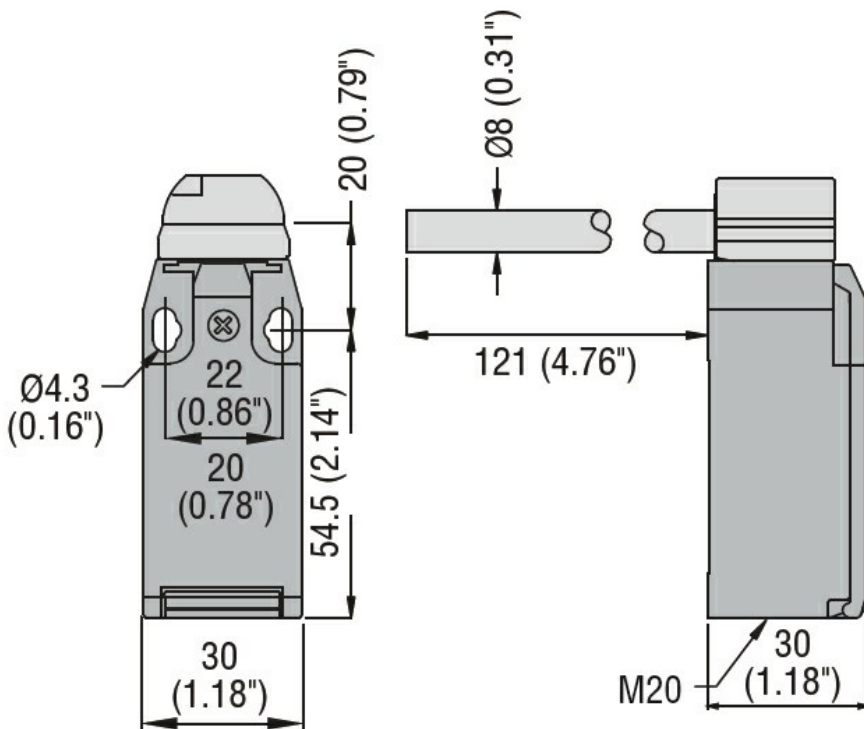

Wiring diagrams

Slow action

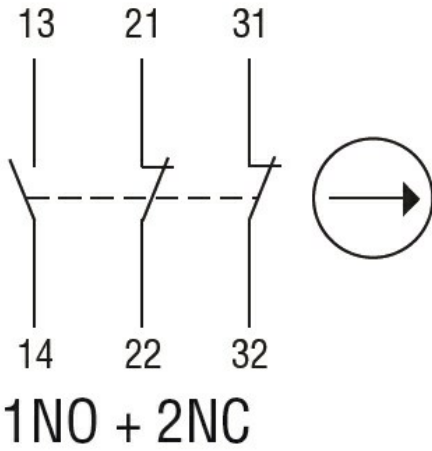

Certifications and compliance

Compliance

CSA C22.2 n° 14

EN 50047

IEC/EN 60204-1

IEC/EN 60947-1

IEC/EN 60947-5-1

UL508

Certificates

CCC

cULus

EAC

ETIM classification

ETIM 8.0

EC000030 - End switch