



# IM30-10BU0-ZU0

IMW

INDUCTIVE PROXIMITY SENSORS

**SICK**  
Sensor Intelligence.



Illustration may differ



## Ordering information

Type	Part no.
IM30-10BUO-ZUO	7902127

**Included in delivery:** BEF-MU-M30 (1)

Other models and accessories → [www.sick.com/IMW](http://www.sick.com/IMW)

## Detailed technical data

### Features

<b>Housing</b>	Cylindrical thread design
<b>Housing</b>	Standard design
<b>Thread size</b>	M30 x 1.5
<b>Diameter</b>	Ø 30 mm
<b>Sensing range <math>S_n</math></b>	10 mm
<b>Safe sensing range <math>S_a</math></b>	8.1 mm
<b>Installation type</b>	Flush
<b>Switching frequency</b>	25 Hz <sup>1)</sup> 30 Hz <sup>2)</sup>
<b>Connection type</b>	Cable, 2-wire, 2 m
<b>Output function</b>	NC
<b>Electrical wiring</b>	AC/DC 2-wire
<b>Enclosure rating</b>	IP67 <sup>3)</sup>
<b>Items supplied</b>	Mounting nut, brass, nickel-plated (2x)

<sup>1)</sup> AC.

<sup>2)</sup> DC.

<sup>3)</sup> According to EN 60529.

### Mechanics/electronics

<b>Supply voltage</b>	20 V AC/DC ... 250 V AC/DC
<b>Voltage drop</b>	≤ 6.5 V AC, ≤ 6 V DC

<sup>1)</sup> Supply voltage  $U_B$  and constant ambient temperature  $T_a$ .

<sup>2)</sup> Of  $S_r$ .

<sup>3)</sup> Repeatability ( $T_a$  not constant).

<sup>4)</sup> AC (+50 °C).

<sup>5)</sup> AC (+80 °C).

<sup>6)</sup> DC.

<sup>7)</sup> 20 ms / 0.5 Hz.

<sup>8)</sup> Miniature fuse to IEC 60217-2 Sheet 1, ≤ 2 A (quick-blow).

<sup>9)</sup> Control of small electromagnetic loads with holding currents < 200 mA.

<sup>10)</sup> Control of solenoids.

<b>Time delay before availability</b>	≤ 8 ms
<b>Hysteresis</b>	1 % ... 15 %
<b>Reproducibility</b>	≤ 10 % <sup>1) 2) 3)</sup>
<b>Temperature drift (of S<sub>r</sub>)</b>	± 10 %
<b>EMC</b>	According to EN 60947-5-2 As per EN 55011, class B
<b>Continuous current I<sub>a</sub></b>	≤ 350 mA <sup>4)</sup> ≤ 250 mA <sup>5)</sup> ≤ 100 mA <sup>6)</sup>
<b>Off-state current</b>	≤ 2.5 mA (AC 250 V) ≤ 1.3 mA (AC 110 V) ≤ 0.8 mA (DC 24 V)
<b>Minimum load current</b>	≥ 5 mA
<b>Short-time withstand current</b>	2.2 A <sup>7)</sup>
<b>Cable material</b>	PUR/PVC
<b>Conductor size</b>	0.5 mm <sup>2</sup>
<b>Short-circuit protection</b>	<sup>8)</sup>
<b>Power-up pulse protection</b>	✓
<b>Shock and vibration resistance</b>	30 g, 11 ms / 10 ... 55 Hz, 1 mm
<b>Ambient operating temperature</b>	-25 °C ... +70 °C
<b>Housing material</b>	Brass, nickel-plated
<b>Sensing face material</b>	Plastic, PBT
<b>Housing length</b>	81 mm
<b>Thread length</b>	59 mm
<b>Tightening torque, max.</b>	≤ 50 Nm
<b>Protection class</b>	II
<b>Rated insulation voltage U<sub>i</sub></b>	250 V AC
<b>Usage category</b>	AC-140 <sup>9)</sup> DC-13 <sup>10)</sup>
<b>Contamination rating</b>	3
<b>Rated impulse withstand voltage</b>	4 kV

<sup>1)</sup> Supply voltage U<sub>B</sub> and constant ambient temperature T<sub>a</sub>.

<sup>2)</sup> Of S<sub>r</sub>.

<sup>3)</sup> Repeatability (T<sub>a</sub> not constant).

<sup>4)</sup> AC (+50 °C).

<sup>5)</sup> AC (+80 °C).

<sup>6)</sup> DC.

<sup>7)</sup> 20 ms / 0.5 Hz.

<sup>8)</sup> Miniature fuse to IEC 60217-2 Sheet 1, ≤ 2 A (quick-blow).

<sup>9)</sup> Control of small electromagnetic loads with holding currents < 200 mA.

<sup>10)</sup> Control of solenoids.

## Safety-related parameters

<b>MTTF<sub>D</sub></b>	971 years
<b>DC<sub>avg</sub></b>	0 %

<b>T<sub>M</sub> (mission time)</b>	20 years
-------------------------------------	----------

Reduction factors

<b>Note</b>	The values are reference values which may vary
<b>Stainless steel (V2A, 304)</b>	Approx. 0.8
<b>Aluminum (Al)</b>	Approx. 0.45
<b>Copper (Cu)</b>	Approx. 0.4

Installation note

<b>Remark</b>	Associated graphic see "Installation"
<b>A</b>	0 mm
<b>B</b>	30 mm
<b>C</b>	30 mm
<b>D</b>	30 mm
<b>E</b>	0 mm
<b>F</b>	80 mm

Classifications

<b>ECLASS 5.0</b>	27270101
<b>ECLASS 5.1.4</b>	27270101
<b>ECLASS 6.0</b>	27270101
<b>ECLASS 6.2</b>	27270101
<b>ECLASS 7.0</b>	27270101
<b>ECLASS 8.0</b>	27270101
<b>ECLASS 8.1</b>	27270101
<b>ECLASS 9.0</b>	27270101
<b>ECLASS 10.0</b>	27270101
<b>ECLASS 11.0</b>	27270101
<b>ECLASS 12.0</b>	27274001
<b>ETIM 5.0</b>	EC002714
<b>ETIM 6.0</b>	EC002714
<b>ETIM 7.0</b>	EC002714
<b>ETIM 8.0</b>	EC002714
<b>UNSPSC 16.0901</b>	39122230

## Installation note

Flush installation

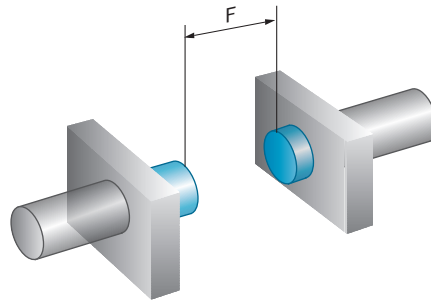
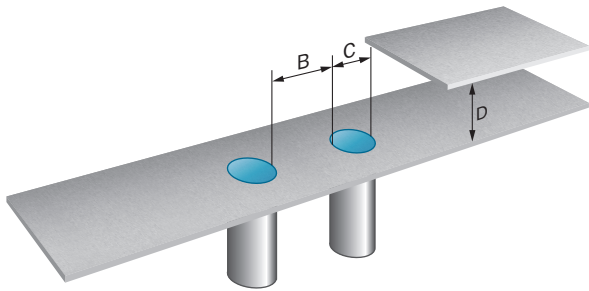

## Connection type

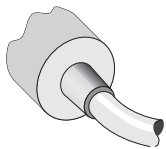

## Connection diagram

Cd-121

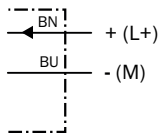

Miniature fuse to IEC60127-2 sheet 1,  $\leq 2$  A (fast acting)

## Dimensional drawing (Dimensions in mm (inch))

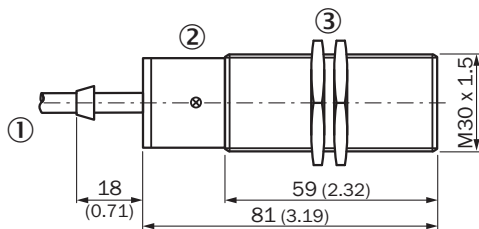

IM30, AC/DC 2-wire, cable, flush



- ① Connection
- ② Display LED
- ③ Fastening nuts (2x); width across 36, metal

Recommended accessories

Other models and accessories → [www.sick.com/IMW](http://www.sick.com/IMW)

	Brief description	Type	Part no.
Universal bar clamp systems			
	Plate N10 for universal clamp bracket, M30, Zinc plated steel (sheet), Zinc die cast (clamping bracket), Universal clamp (5322626), mounting hardware	BEF-KHS-N10	2062372
Mounting brackets and plates			
	Mounting plate for M30 sensors, steel, zinc coated, without mounting hardware	BEF-WG-M30	5321871
	Mounting bracket for M30 sensors, steel, zinc coated, without mounting hardware	BEF-WN-M30	5308445

## SICK AT A GLANCE

SICK is one of the leading manufacturers of intelligent sensors and sensor solutions for industrial applications. A unique range of products and services creates the perfect basis for controlling processes securely and efficiently, protecting individuals from accidents and preventing damage to the environment.

We have extensive experience in a wide range of industries and understand their processes and requirements. With intelligent sensors, we can deliver exactly what our customers need. In application centers in Europe, Asia and North America, system solutions are tested and optimized in accordance with customer specifications. All this makes us a reliable supplier and development partner.

Comprehensive services complete our offering: SICK LifeTime Services provide support throughout the machine life cycle and ensure safety and productivity.

For us, that is “Sensor Intelligence.”

## WORLDWIDE PRESENCE:

Contacts and other locations –[www.sick.com](http://www.sick.com)