



# LUT1B-41235

LUT1

LUMINESCENCE SENSORS

**SICK**  
Sensor Intelligence.



Illustration may differ



## Ordering information

Type	Part no.
LUT1B-41235	1024126

Other models and accessories → [www.sick.com/LUT1](http://www.sick.com/LUT1)

## Detailed technical data

### Features

<b>Dimensions (W x H x D)</b>	23 mm x 70 mm x 60 mm
<b>Sensing distance</b>	≤ 150 mm <sup>1)</sup>
<b>Housing design</b>	Middle
<b>Working range</b>	60 mm ... 160 mm
<b>Light source</b>	LED, blue <sup>2)</sup>
<b>Wave length</b>	470 nm
<b>Light emission</b>	Long side
<b>Light spot size</b>	6 mm x 14 mm
<b>Receiving filters</b>	OG 590
<b>Receiving range</b>	590 nm ... 750 nm
<b>Adjustment</b>	Double teach-in button
<b>Output function</b>	Light switching

<sup>1)</sup> From leading edge of lens.

<sup>2)</sup> Average service life: 100,000 h at T<sub>J</sub> = +25 °C.

### Mechanics/electronics

<b>Supply voltage</b>	10 V DC ... 30 V DC <sup>1)</sup>
<b>Ripple</b>	< 5 V <sub>pp</sub> <sup>2)</sup>
<b>Current consumption</b>	< 40 mA <sup>3)</sup>
<b>Switching frequency</b>	600 Hz <sup>4)</sup>

<sup>1)</sup> Limit values when operated in short-circuit protected network: max. 8 A.

<sup>2)</sup> May not exceed or fall below U<sub>V</sub> tolerances.

<sup>3)</sup> Without load.

<sup>4)</sup> With light/dark ratio 1:1, without timer stage.

<sup>5)</sup> Signal transit time with resistive load.

<sup>6)</sup> Control output.

<sup>7)</sup> Reference voltage DC 50 V.

<b>Response time</b>	850 $\mu$ s <sup>5)</sup>
<b>Switching output</b>	PNP
<b>Switching output (voltage)</b>	PNP: HIGH = $U_V \leq 2$ V / LOW approx. 0 V
<b>Switching mode</b>	Light switching <sup>6)</sup>
<b>Output current <math>I_{max}</math></b>	200 mA
<b>Connection type</b>	Male connector M12, 5-pin
<b>Protection class</b>	III <sup>7)</sup>
<b>Circuit protection</b>	$U_V$ connections, reverse polarity protected Output Q short-circuit protected Interference pulse suppression
<b>Enclosure rating</b>	IP67
<b>Weight</b>	240 g
<b>Housing material</b>	Metal, zinc diecast

1) Limit values when operated in short-circuit protected network: max. 8 A.

2) May not exceed or fall below  $U_V$  tolerances.

3) Without load.

4) With light/dark ratio 1:1, without timer stage.

5) Signal transit time with resistive load.

6) Control output.

7) Reference voltage DC 50 V.

## Ambient data

<b>Ambient operating temperature</b>	-20 °C ... +60 °C
<b>Ambient temperature, storage</b>	-40 °C ... +70 °C
<b>Shock load</b>	According to IEC 60068

## Classifications

<b>eCl@ss 5.0</b>	27270908
<b>eCl@ss 5.1.4</b>	27270908
<b>eCl@ss 6.0</b>	27270908
<b>eCl@ss 6.2</b>	27270908
<b>eCl@ss 7.0</b>	27270908
<b>eCl@ss 8.0</b>	27270908
<b>eCl@ss 8.1</b>	27270908
<b>eCl@ss 9.0</b>	27270908
<b>eCl@ss 10.0</b>	27270908
<b>eCl@ss 11.0</b>	27270908
<b>eCl@ss 12.0</b>	27270908
<b>ETIM 5.0</b>	EC001822
<b>ETIM 6.0</b>	EC001822
<b>ETIM 7.0</b>	EC001822
<b>ETIM 8.0</b>	EC001822
<b>UNSPSC 16.0901</b>	39121528

**Dimensional drawing** (Dimensions in mm (inch))

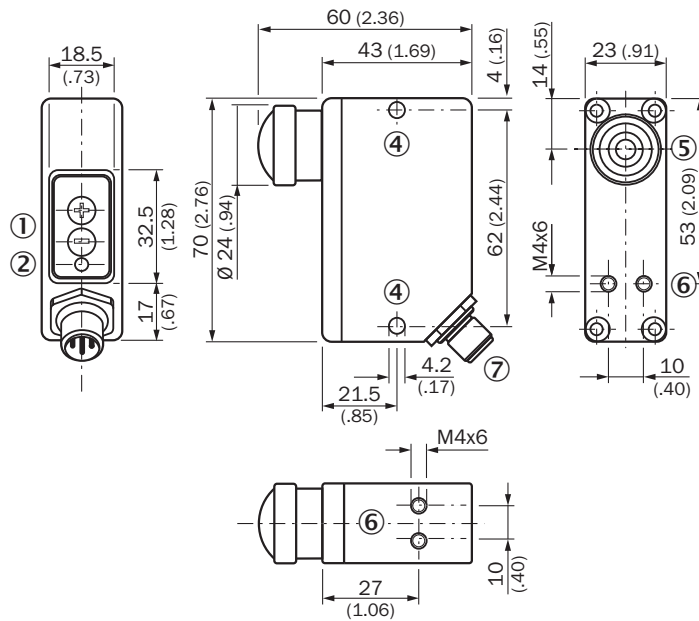

- ① Control elements
- ② LED signal strength indicator
- ④ Fixing hole
- ⑤ Optical axis
- ⑥ Threaded mounting hole
- ⑦ Male connector M12

**Adjustments**

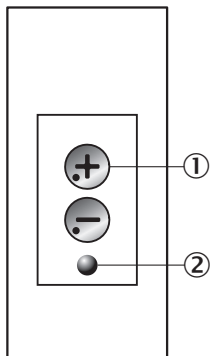

- ① Control elements
- ② LED signal strength indicator

## Pin assignment

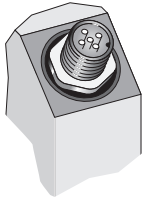

## Connection diagram

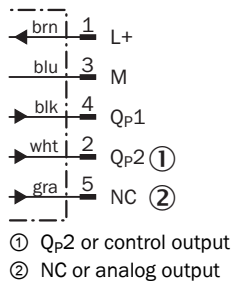

## Sensing distance

Sensing distance

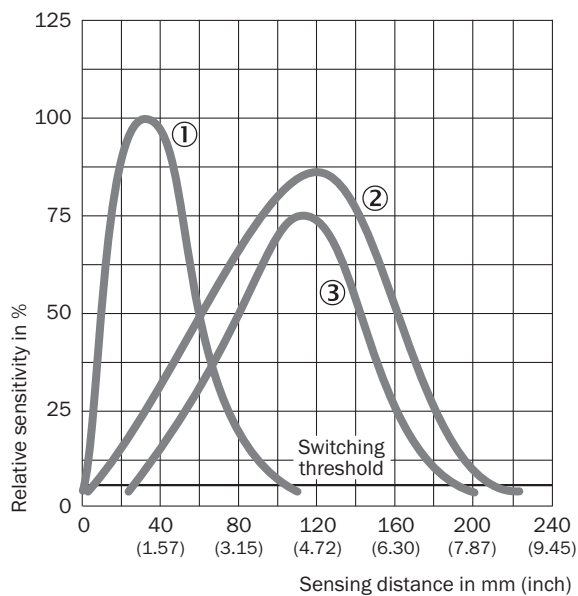

- ① LUT1B sensing distance 50 mm; scan material: acryl orange
- ② LUT1B sensing distance 150 mm; scan material: acryl orange
- ③ LUT1U sensing distance 150 mm; scan material: SICK Luminescence reference 100 %

## Light spot size

Light spot size

**Sensing distance 50 mm**

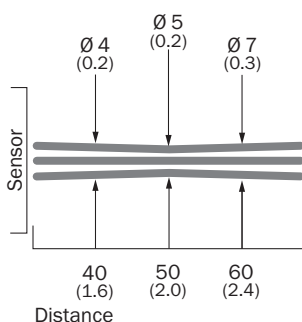

**Sensing distance 80 mm**

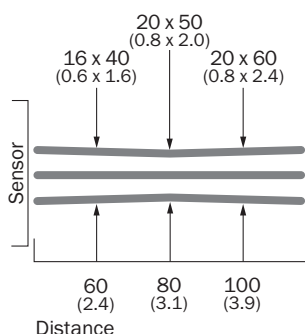

**Sensing distance 150 mm**

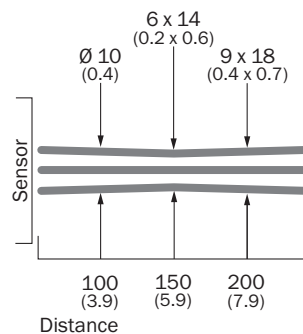



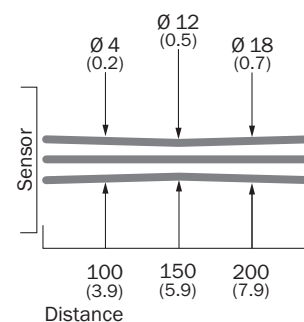



**Sensing distance 150 mm**





All dimensions in mm (inch)

## Recommended accessories

Other models and accessories → [www.sick.com/LUT1](http://www.sick.com/LUT1)

	Brief description	Type	Part no.
<b>Reference materials</b>			
	Thick chalk, red fluorescent, 12 units	LUM-FT	1004460
	Writing chalk, red fluorescence	LUM-KLK	1002959
<b>Universal bar clamp systems</b>			
	Universal clamp bracket for rod mounting, steel, zinc coated, without mounting hardware	BEF-KHS-KH1	2022726
	Mounting bar, straight, 200 mm, steel, steel, zinc coated, without mounting hardware	BEF-MS12G-A	4056054
	Mounting bar, straight, 300 mm, steel, steel, zinc coated, without mounting hardware	BEF-MS12G-B	4056055
	Mounting bar, L-shaped, 150 mm x 150 mm, steel, steel, zinc coated, without mounting hardware	BEF-MS12L-A	4056052
	Mounting bar, L-shaped, 250 x 250 mm, steel, steel, zinc coated, without mounting hardware	BEF-MS12L-B	4056053
<b>Plug connectors and cables</b>			
	Head A: female connector, M12, 5-pin, straight, A-coded Head B: Flying leads Cable: Sensor/actuator cable, PVC, unshielded, 2 m	YF2A15-020VB5XLEAX	2096239
	Head A: female connector, M12, 5-pin, straight, A-coded Head B: Flying leads Cable: Sensor/actuator cable, PVC, unshielded, 5 m	YF2A15-050VB5XLEAX	2096240

	<b>Brief description</b>	<b>Type</b>	<b>Part no.</b>
	Head A: female connector, M12, 5-pin, straight, A-coded Head B: Flying leads Cable: Sensor/actuator cable, PVC, unshielded, 10 m	YF2A15-100VB5XLEAX	2096241
	Head A: female connector, M12, 5-pin, angled, A-coded Head B: Flying leads Cable: Sensor/actuator cable, PVC, unshielded, 2 m	YG2A15-020VB5XLEAX	2096215
	Head A: female connector, M12, 5-pin, angled, A-coded Head B: Flying leads Cable: Sensor/actuator cable, PVC, unshielded, 5 m	YG2A15-050VB5XLEAX	2096216
	Head A: female connector, M12, 5-pin, angled, A-coded Head B: Flying leads Cable: Sensor/actuator cable, PVC, unshielded, 10 m	YG2A15-100VB5XLEAX	2096217
	Head A: female connector, M12, 5-pin, straight Cable: unshielded	DOS-1205-G	6009719
	 Head A: female connector, M12, 5-pin, angled Cable: unshielded	DOS-1205-W	6009720

## SICK AT A GLANCE

SICK is one of the leading manufacturers of intelligent sensors and sensor solutions for industrial applications. A unique range of products and services creates the perfect basis for controlling processes securely and efficiently, protecting individuals from accidents and preventing damage to the environment.

We have extensive experience in a wide range of industries and understand their processes and requirements. With intelligent sensors, we can deliver exactly what our customers need. In application centers in Europe, Asia and North America, system solutions are tested and optimized in accordance with customer specifications. All this makes us a reliable supplier and development partner.

Comprehensive services complete our offering: SICK LifeTime Services provide support throughout the machine life cycle and ensure safety and productivity.

For us, that is “Sensor Intelligence.”

## WORLDWIDE PRESENCE:

Contacts and other locations –[www.sick.com](http://www.sick.com)