



Product designation
Product type designation

Power contactor
BF50

Contact characteristics

Number of poles	Nr.	4
Rated insulation voltage U_i IEC/EN	V	1000
Rated impulse withstand voltage U_{imp}	kV	8
Operational frequency	min	Hz 25
	max	Hz 400
IEC Conventional free air thermal current I_{th}	A	90
Operational current I_e	AC-1 ($\leq 40^\circ\text{C}$)	A 90
	AC-1 ($\leq 55^\circ\text{C}$)	A 75
	AC-1 ($\leq 70^\circ\text{C}$)	A 65
	AC-3 ($\leq 440\text{V} \leq 55^\circ\text{C}$)	A 50
	AC-4 (400V)	A 28
Rated operational current AC-3 ($T \leq 55^\circ\text{C}$)	230V	A 50
	400V	A 50
	415V	A 50
	440V	A 50
	500V	A 44
	690V	A 39
	1000V	A 23
Rated operational power AC-1 ($T \leq 40^\circ\text{C}$)	230V	kW 34
	400V	kW 59
	500V	kW 74
	690V	kW 102
IEC max current I_e in DC1 with $L/R \leq 1\text{ms}$ with 1 poles in series	$\leq 24\text{V}$	A 45
	48V	A 40
	75V	A 40
	110V	A 8
	220V	A –
IEC max current I_e in DC1 with $L/R \leq 1\text{ms}$ with 2 poles in series	$\leq 24\text{V}$	A 60
	48V	A 60
	75V	A 60
	110V	A 50
	220V	A 7
IEC max current I_e in DC1 with $L/R \leq 1\text{ms}$ with 3 poles in series	$\leq 24\text{V}$	A 60
	48V	A 60
	75V	A 60

	110V	A	55
	220V	A	75
<hr/>			
IEC max current I _e in DC1 with L/R ≤ 1ms with 4 poles in series			
	≤24V	A	60
	48V	A	60
	75V	A	60
	110V	A	60
	220V	A	90
<hr/>			
IEC max current I _e in DC3-DC5 with L/R ≤ 15ms with 1 poles in series			
	≤24V	A	30
	48V	A	25
	75V	A	22
	110V	A	3
	220V	A	–
<hr/>			
IEC max current I _e in DC3-DC5 with L/R ≤ 15ms with 2 poles in series			
	≤24V	A	35
	48V	A	35
	75V	A	30
	110V	A	25
	220V	A	5
<hr/>			
IEC max current I _e in DC3-DC5 with L/R ≤ 15ms with 3 poles in series			
	≤24V	A	50
	48V	A	50
	75V	A	45
	110V	A	30
	220V	A	40
<hr/>			
IEC max current I _e in DC3-DC5 with L/R ≤ 15ms with 4 poles in series			
	≤24V	A	55
	48V	A	55
	75V	A	55
	110V	A	45
	220V	A	50
<hr/>			
Short-time allowable current for 10s (IEC/EN60947-1)		A	400
<hr/>			
Protection fuse			
	gG (IEC)	A	100
	aM (IEC)	A	50
<hr/>			
Making capacity (RMS value)		A	500
<hr/>			
Breaking capacity at voltage			
	440V	A	400
	500V	A	352
	690V	A	312
<hr/>			
Resistance per pole (average value)		mΩ	0.8
<hr/>			
Power dissipation per pole (average value)			
	I _{th}	W	6.5
	AC-3	W	2
<hr/>			
Tightening torque for terminals			
	min	Nm	4
	max	Nm	5
	min	I _{bin}	2.95
	max	I _{bin}	3.69
<hr/>			
Tightening torque for coil terminal			
	min	Nm	0.8
	max	Nm	1

	min	I _{bin}	0.8
	max	I _{bin}	0.74
Max number of wires simultaneously connectable		Nr.	2
Conductor section			
AWG/Kcmil			
	max		2
Flexible w/o lug conductor section			
	min	mm ²	1.5
	max	mm ²	35
Flexible c/w lug conductor section			
	min	mm ²	1.5
	max	mm ²	35
Power terminal protection according to IEC/EN 60529			IP20 front
Mechanical features			
Operating position			
	normal allowable		Vertical plan ±30°
Fixing			Screw / DIN rail 35mm
Weight		g	1240
Conductor section			
AWG/kcmil conductor section			
	max		2
Operations			
Mechanical life		cycles	15000000
Electrical life		cycles	1400000
Safety related data			
Performance level B10d according to EN/ISO 13489-1			
	rated load	cycles	1400000
	mechanical load	cycles	15000000
Mirror contacts according to IEC/EN 60947-4-1			yes
EMC compatibility			yes
AC coil operating			
Rated AC voltage at 50/60Hz		V	400
AC operating voltage			
of 50/60Hz coil powered at 50Hz			
pick-up	min	%Us	80
	max	%Us	110
drop-out	min	%Us	20
	max	%Us	55
of 50/60Hz coil powered at 60Hz			
pick-up	min	%Us	85
	max	%Us	110
drop-out	min	%Us	40
	max	%Us	55
AC average coil consumption at 20°C			
of 50/60Hz coil powered at 50Hz			
	in-rush	VA	210
	holding	VA	15

of 50/60Hz coil powered at 60Hz

in-rush	VA	195
holding	VA	13

of 60Hz coil powered at 60Hz

in-rush	VA	210
holding	VA	15

Dissipation at holding $\leq 20^{\circ}\text{C}$ 50Hz

W	5
---	---

Max cycles frequency

Mechanical operation

cycles/h	3600
----------	------

Operating times

Average time for Us control

in AC

Closing NO

min	ms	12
max	ms	28

Opening NO

min	ms	8
max	ms	22

in DC

Closing NO

min	ms	40
max	ms	85

Opening NO

min	ms	20
max	ms	55

UL technical data

Full-load current (FLA) for three-phase AC motor

at 480V	A	52
at 600V	A	41

Yielded mechanical performance

for single-phase AC motor

110/120V	HP	5
230V	HP	10

for three-phase AC motor

200/208V	HP	15
220/230V	HP	20
460/480V	HP	40
575/600V	HP	40

General USE

Contactor

AC current	A	90
------------	---	----

Short-circuit protection fuse, 600V

High fault

Short circuit current	kA	100
Fuse rating	A	150
Fuse class		J

Standard fault

Short circuit current	kA	5
Fuse rating	A	150
Fuse class		RK5

Ambient conditions

Temperature

Operating temperature

min	$^{\circ}\text{C}$	-50
-----	--------------------	-----

Storage temperature	max	°C	70
	min	°C	-60
Max altitude	max	°C	80
		m	3000

Resistance & Protection

Pollution degree

3

Dimensions

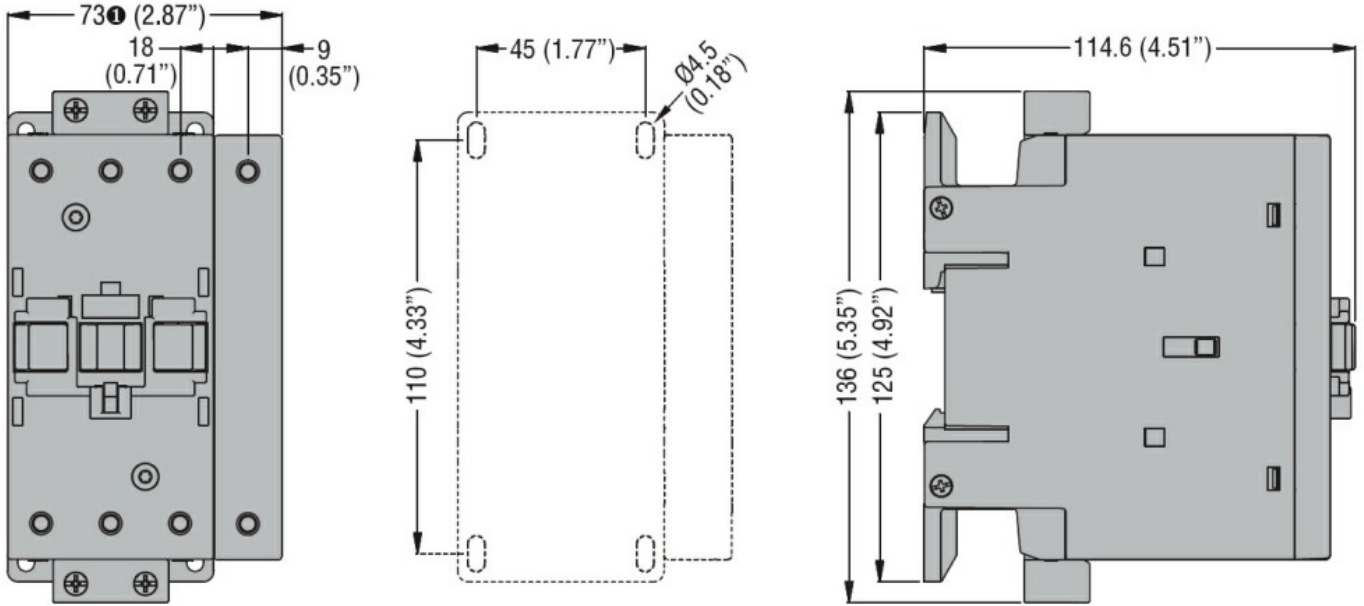

① BF80T2 82mm/3.23"

Wiring diagrams

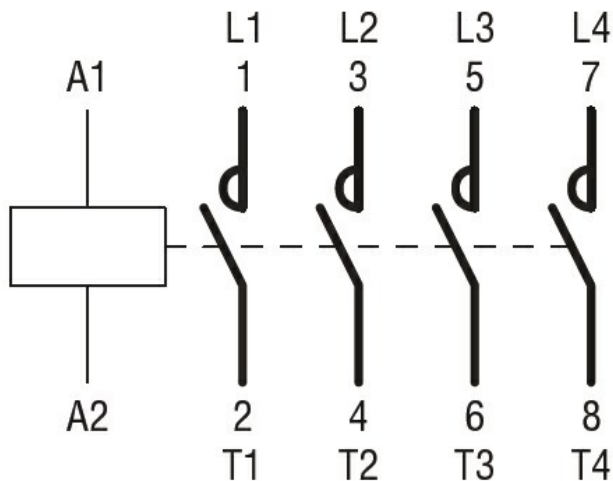

Certifications and compliance

Compliance

- CSA C22.2 n° 60947-1
- CSA C22.2 n° 60947-4-1
- IEC/EN/BS 60947-1
- IEC/EN/BS 60947-4-1
- UL 60947-1
- UL 60947-4-1

Certificates

CCC
cULus

ETIM classification

ETIM 8.0

EC000066 -
Power contactor,
AC switching