

Part number

MAP 10 LS232



Surface mounting housing, C-TYPE series, with 1 lever, M32 x 2 cable entry, size "57.27", high construction, with metal cover

Product description	
Product type	Surface mounting housing
Series	C-TYPE
Closing type	With 1 lever
Size	Size 57.27
Cable entry	With cable entry M32 x 2
Specification	High construction, with metal cover
Technical data	
IP degree of protection	IP65
Further technical details	
Weight	376,40 g
Operating temperature range (min, max)	-40°C...+125°C

Material properties	
Other materials	Lever: Stainless steel, polyamide (PA) Gasket: NBR
Colour	RAL 7040 grey
RoHs conformity	Compliant
China RoHs - EFUP	E
REACH SVHC substances	No
Approvals / Standards	
Certifications	DNV, BV
UL	ECBT2
cUL	ECBT8
General ordering information	
EAN13 code	8015747051200
eCl@ss 8.1	27440202
ETIM 7.0	EC000437
Packaging Information	
Packaging length	475,00 mm
Packaging height	200,00 mm
Packaging width	150,00 mm
Packaging weight	3,80 kg
Packaging volume	14,25 dm ³
Packaging description	Carton box
Packaging quantity	10 Pcs
Packaging EAN code	8015747244411
Sub-packaging weight	1,90 kg
Sub-packaging description	Plastic packaging
Sub-packaging quantity	5 Pcs
Sub-packaging EAN barcode	8015747051217

Part number

MAP 10 LS232



Catalogue drawings

CHP L - CAP L MHP L - MAP L



CHP LS - CAP LS MHP LS - MAP LS

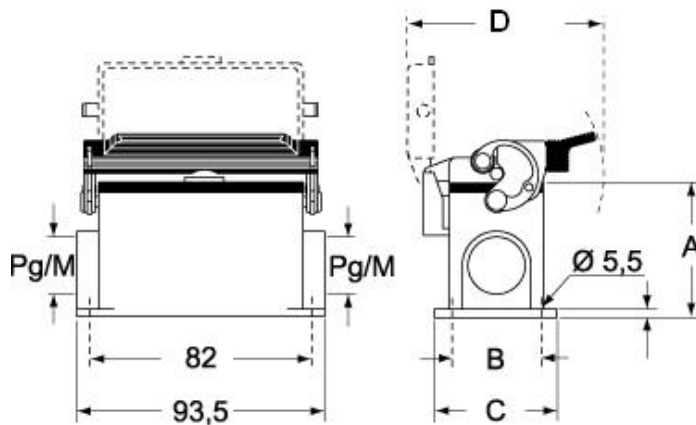

Notes

Dimensions shown in mm are not binding and may be changed without notice.