



# MRS1104A-111011P01 Set

PeopleCounter

3D LIDAR SENSORS

**SICK**  
Sensor Intelligence.



### Ordering information

Type	Part no.
MRS1104A-111011P01 Set	1114292

**Included in delivery:** Connection box (1), Mounting kit 1a (1), Connection box mounting kit (1), MRS1104A-111011S01 (1), Power supply unit (1), YM2A15-050UB5XLEAX (1), Signal lamps (1)

Set only for the European market

Other models and accessories → [www.sick.com/PeopleCounter](http://www.sick.com/PeopleCounter)



### Detailed technical data

#### Features

<b>Measurement principle</b>	HDDM <sup>+</sup>
<b>Light source</b>	Infrared (850 nm)
<b>Laser class</b>	1 (IEC 60825-1:2014, EN 60825-1:2014)
<b>Aperture angle</b>	Horizontal 275° Vertical 7.5° (Over 4 scan layers)
<b>Scanning frequency</b>	50 Hz, 4 x 12.5 Hz
<b>Angular resolution</b>	0.25°
<b>Heating</b>	Self-heating
<b>Working range</b>	10 m (Width of the counting range)
<b>Scanning range</b>	At 10% remission factor 16 m At 90% remission factor 30 m
<b>Spot size</b>	10.4 mrad x 8.7 mrad
<b>Amount of evaluated echoes</b>	3

#### Mechanics/electronics

<b>Connection type</b>	M12 round connectors with swivel connector
<b>Supply voltage</b>	10 V DC ... 30 V DC
<b>Power consumption</b>	≤ 13 W, Start-up phase max. 30 W for 1 s
<b>Housing</b>	AlSi12, Optics cover: polycarbonate
<b>Protection class</b>	III (IEC 61140:2016-11)
<b>Electrical safety</b>	IEC 61010-1:2010-06
<b>Weight</b>	1.2 kg
<b>Dimensions (L x W x H)</b>	151.9 mm x 150 mm x 92.5 mm

<b>Mounting method</b>	Mounting height 2 m ... 5 m (typ. 2.5 m ... 3.5 m)
------------------------	--

## Performance

<b>Output data LIDAR-LOC</b>	IMU (secondary sensor data)
<b>Scan/frame rate</b>	55,000 measurement point/s ... 165,000 measurement point/s
<b>Response time</b>	4 layers, typ. 20 ms 1 layer, typ. 80 ms
<b>Systematic error</b>	± 60 mm
<b>Statistical error</b>	≤ 30 mm
<b>Accuracy</b>	> 98 %
<b>Integrated application</b>	People counting

## Interfaces

<b>Ethernet</b>	✓, TCP/IP, UDP/IP
Data transmission rate	10/100 MBit/s
<b>Digital inputs/outputs</b>	I/O (8 (Multiport))
<b>Output data</b>	IMU (secondary sensor data)
<b>Optical indicators</b>	LEDs
<b>Operator interfaces</b>	Web server
<b>Configuration software</b>	SICK AppStudio

## Ambient data

<b>Object remission</b>	2 % ... > 1,000 % (Reflector)
<b>Electromagnetic compatibility (EMC)</b>	EN 61000-6-2:2005, EN 61000-6-3:2007+A1:2011
<b>Vibration resistance</b>	IEC 60068-2-6:2007
<b>Shock resistance</b>	IEC 60068-2-27:2008
<b>Ambient operating temperature</b>	-30 °C ... +50 °C
<b>Storage temperature</b>	-40 °C ... +75 °C
<b>Ambient light immunity</b>	80 klx

## General notes

<b>Note on use</b>	The sensor does not constitute a safety component as defined by relevant legislation on machine safety.
--------------------	---

## Classifications

<b>ECLASS 5.0</b>	27270990
<b>ECLASS 5.1.4</b>	27270990
<b>ECLASS 6.0</b>	27270913
<b>ECLASS 6.2</b>	27270913
<b>ECLASS 7.0</b>	27270913
<b>ECLASS 8.0</b>	27270913
<b>ECLASS 8.1</b>	27270913
<b>ECLASS 9.0</b>	27270913
<b>ECLASS 10.0</b>	27270913
<b>ECLASS 11.0</b>	27270913
<b>ECLASS 12.0</b>	27270913

# MRS1104A-111011P01 Set | PeopleCounter

3D LIDAR SENSORS

<b>ETIM 5.0</b>	EC002550
<b>ETIM 6.0</b>	EC002550
<b>ETIM 7.0</b>	EC002550
<b>ETIM 8.0</b>	EC002550
<b>UNSPSC 16.0901</b>	41111615

Dimensional drawing (Dimensions in mm (inch))

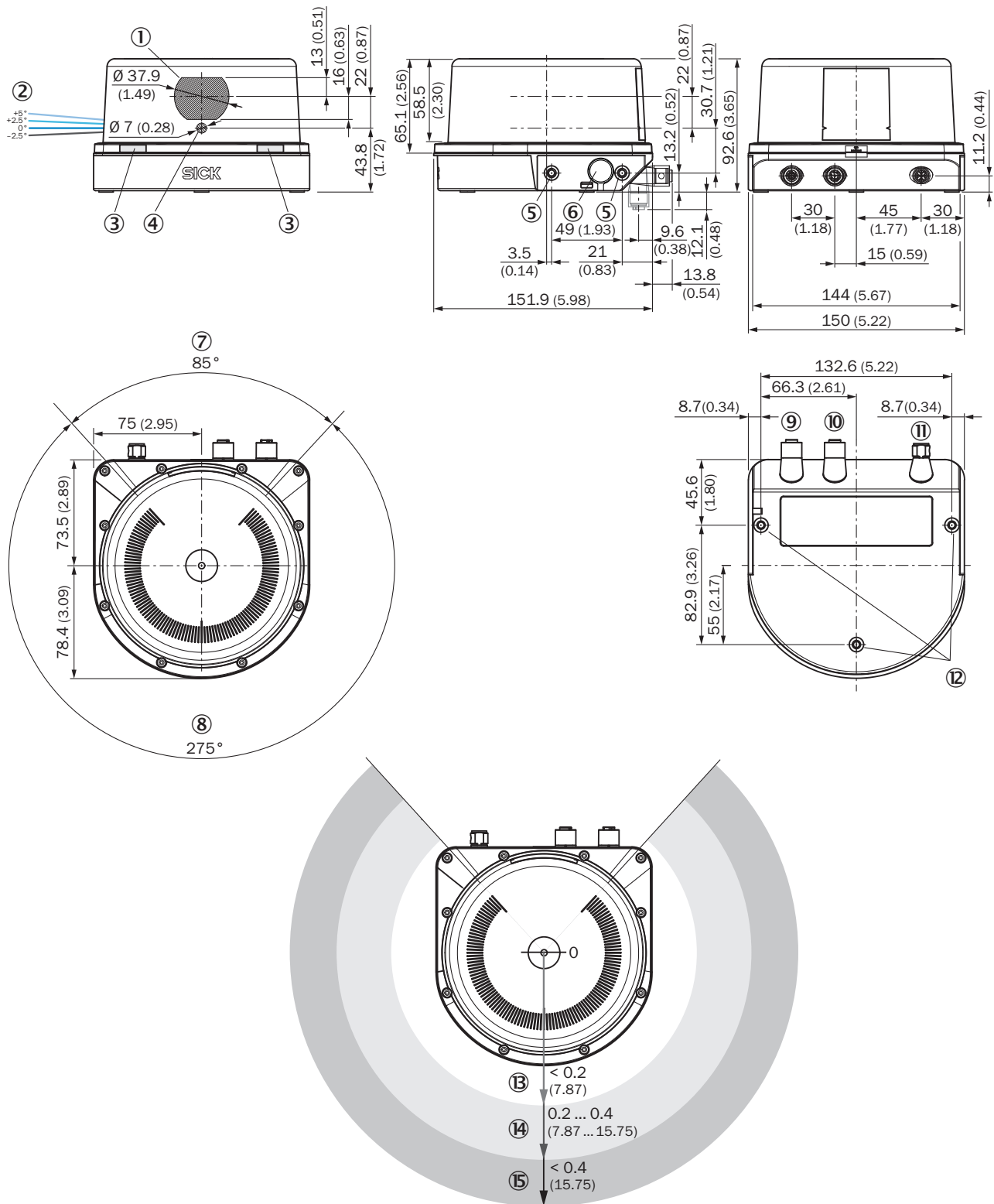

- ① Receiver
- ② Laser aperture angle, layers 1 to 4
- ③ Status LEDs
- ④ Sender
- ⑤ Mounting hole M5 x 7.5
- ⑥ Pressure compensation element

- ⑦ Blind zone
- ⑧ Field of view
- ⑨ Ethernet connection
- ⑩ I/O connection
- ⑪ POWER connection
- ⑫ Mounting hole M5 x 7,5
- ⑬ Close range (no detection or measurement possible)
- ⑭ Detection zone
- ⑮ Measuring range

### Working range diagram

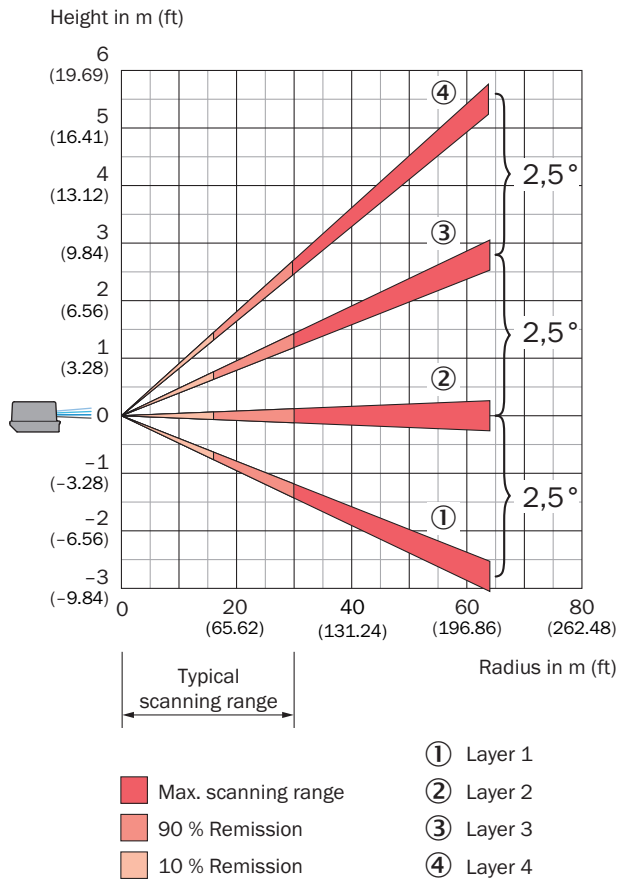

Scanning range in m

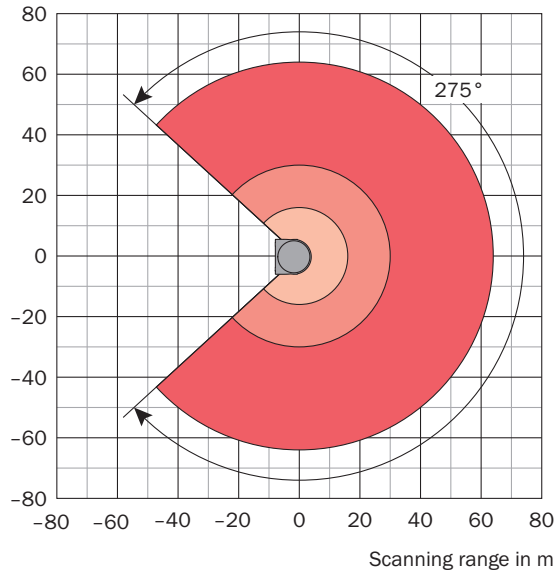

- Scanning range max. 64 m
- Scanning range for objects up to 90 % remission 30 m
- Scanning range for objects up to 10 % Remission 16 m

### Assembly note

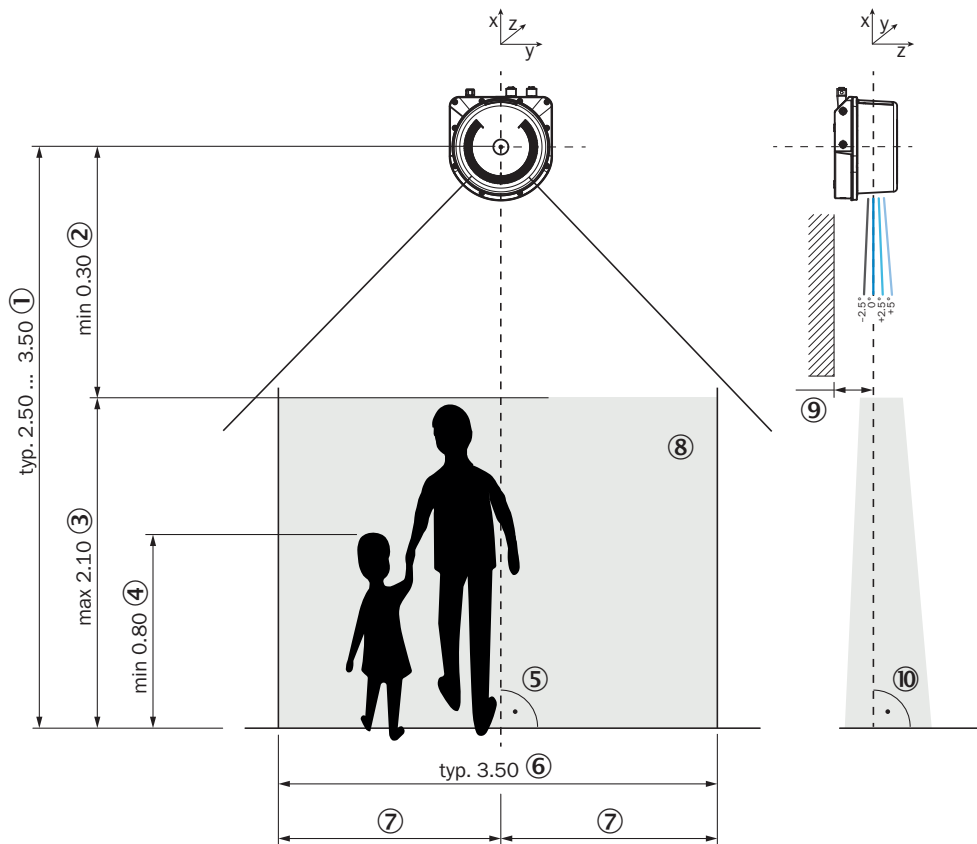

- ① Mounting height 2 m ... 5 m (typ. 2.5 m ... 3.5 m)
- ② Minimum distance from origin of measurement to people
- ③ Size of person: max. 2.1 m
- ④ Size of person: min. 0.8 m
- ⑤ Tilt of device around y-axis: typically 0°; max. ± 10°
- ⑥ Horizontal detection area: typically 3.5 m; max. 10 m
- ⑦ Position of the device over the detection area: typically central to prevent shading by people walking by
- ⑧ Detection area: typically 3.5 m x 2.1 m (W x H); max. 10 m x 2.1 m (W x H)
- ⑨ Distance of the device to objects (e.g. walls): observe scan plane angle (-2.5°/0°/+2.5°/+5°), if needed increase distance or tilt device around y-axis
- ⑩ Tilt of device around y-axis: typically 0°; max. ± 10°

### Connection type

Ethernet

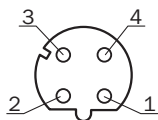

M12 female connector, 4-pin, D-coded

- ① TX+
- ② RX+
- ③ TX-
- ④ RX-



I/O

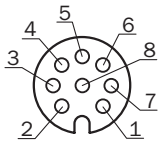

Connector M12, 8-pin, A-coded

- ① IN1/OUT1
- ② IN2/OUT2
- ③ IN3/OUT3
- ④ IN4/OUT4
- ⑤ IN5/OUT5
- ⑥ IN6/OUT6
- ⑦ GND IN<sub>x</sub>/OUT<sub>x</sub>
- ⑧ IN7/OUT7

Power

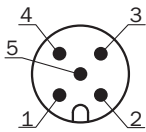

Connector M12, 5-pin, A-coded

- ① VS 10...30 V
- ② Reserved
- ③ GND
- ④ IN8/OUT8
- ⑤ Reserved

### Overview

SICK AppSpace



### Recommended services

Additional services → [www.sick.com/PeopleCounter](http://www.sick.com/PeopleCounter)

	Type	Part no.
Extended warranty		
<ul style="list-style-type: none"> <li>• <b>Product area:</b> Identification solutions, machine vision, Detection and ranging solutions, safety camera sensors, Safety laser scanners, Safety radar sensors</li> <li>• <b>Range of services:</b> The services correspond to the scope of the statutory manufacturer warranty (SICK general terms of delivery).</li> <li>• <b>Duration:</b> Five-year warranty from delivery date.</li> </ul>	Extended warranty for a total of five years from delivery date	1680671

## SICK AT A GLANCE

SICK is one of the leading manufacturers of intelligent sensors and sensor solutions for industrial applications. A unique range of products and services creates the perfect basis for controlling processes securely and efficiently, protecting individuals from accidents and preventing damage to the environment.

We have extensive experience in a wide range of industries and understand their processes and requirements. With intelligent sensors, we can deliver exactly what our customers need. In application centers in Europe, Asia and North America, system solutions are tested and optimized in accordance with customer specifications. All this makes us a reliable supplier and development partner.

Comprehensive services complete our offering: SICK LifeTime Services provide support throughout the machine life cycle and ensure safety and productivity.

For us, that is “Sensor Intelligence.”

## WORLDWIDE PRESENCE:

Contacts and other locations –[www.sick.com](http://www.sick.com)