

Wiser Boiler Relay

Device user guide

Information about features and functionality of the device.

10/2022

Legal Information

The Schneider Electric brand and any trademarks of Schneider Electric SE and its subsidiaries referred to in this guide are the property of Schneider Electric SE or its subsidiaries. All other brands may be trademarks of their respective owners.

This guide and its content are protected under applicable copyright laws and furnished for informational use only. No part of this guide may be reproduced or transmitted in any form or by any means (electronic, mechanical, photocopying, recording, or otherwise), for any purpose, without the prior written permission of Schneider Electric.

Schneider Electric does not grant any right or license for commercial use of the guide or its content, except for a non-exclusive and personal license to consult it on an "as is" basis. Schneider Electric products and equipment should be installed, operated, serviced, and maintained only by qualified personnel.

As standards, specifications, and designs change from time to time, information contained in this guide may be subject to change without notice.

To the extent permitted by applicable law, no responsibility or liability is assumed by Schneider Electric and its subsidiaries for any errors or omissions in the informational content of this material or consequences arising out of or resulting from the use of the information contained herein.

Table of Contents

Safety information	5
Wiser Boiler Relay	6
For your safety	6
About the device	7
Installing the device	7
Pairing the device	8
Configuring the device	10
Renaming the device	10
Setting the device control	10
Setting heat source type	11
Identifying the device	13
Removing the device	13
Resetting the device	14
Using the device	14
Emergency heating	14
LED indications	16
Troubleshooting	16
Technical Data	17

Safety information

Important information

Read these instructions carefully and look at the equipment to become familiar with the device before trying to install, operate, service, or maintain it. The following special messages may appear throughout this manual or on the equipment to warn of potential hazards or to call attention to information that clarifies or simplifies a procedure.



The addition of either symbol to a “Danger” or “Warning” safety label indicates that an electrical hazard exists which will result in personal injury if the instructions are not followed.



This is the safety alert symbol. It is used to alert you to potential personal injury hazards. Obey all safety messages that accompany this symbol to avoid possible injury or death.

⚡ ⚠ DANGER
DANGER indicates a hazardous situation which, if not avoided, will result in death or serious injury. Failure to follow these instructions will result in death or serious injury.
⚠ WARNING
WARNING indicates a hazardous situation which, if not avoided, could result in death or serious injury.
⚠ CAUTION
CAUTION indicates a hazardous situation which, if not avoided, could result in minor or moderate injury.
NOTICE
NOTICE is used to address practices not related to physical injury.

Wiser Boiler Relay

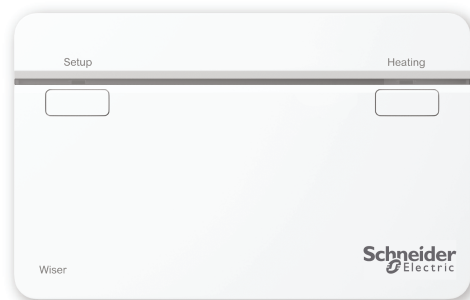

CCTFR6001

For your safety

⚠ WARNING

HAZARD OF ELECTRIC SHOCK, EXPLOSION, OR ARC FLASH

The wallplate terminals may carry electrical current even when the device is not working. When working on the device always disconnect the device from the supply using the fuse in the incoming circuit.

Failure to follow these instructions can result in death, serious injury, or equipment damage.

NOTICE

RISK OF DAMAGE TO DEVICE

Always operate the product in compliance with the specified technical data.

Failure to follow these instructions can result in equipment damage.

About the device

The Wiser Boiler Relay (hereinafter referred to as **Boiler Relay**) allows control of a domestic boiler in water based central heating applications. The Boiler Relay contains a 2 A relay that can be connected to a boiler directly or to auxiliary control equipment such as a motorised valve.

The Boiler Relay also contains a digital boiler interface that can be used to provide direct control of the boiler demand using the OpenTherm®.

NOTE: A Wiser Radiator thermostat or Room thermostat is mandatory for the Boiler Relay to work.

Features of the Boiler Relay:

- Controls the heat source (boiler, heat pump, motorized valve, or circulating pumps).
- You can manually override heating.

Operating elements

- A. Setup button
- B. Heating button
- C. Status LEDs

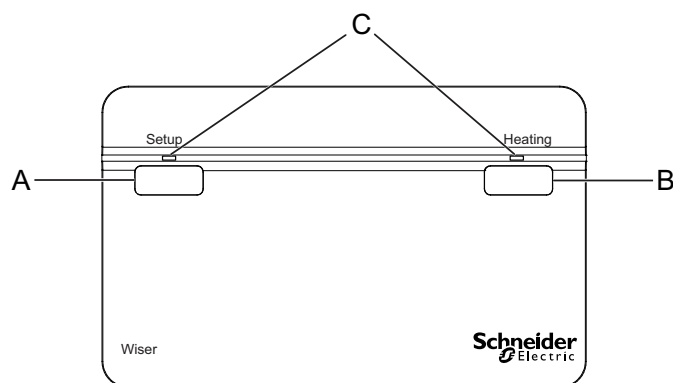



Installing the device

Refer to the installation instruction supplied with this product.

Pairing the device

Using the Wiser Home app, pair your Boiler Relay with the Wiser system to access and control the Boiler Relay.

Follow the steps below to pair the Boiler Relay:

1. On the Home page, tap  icon.
2. Tap **Devices** >  icon and tap **Climate** (tab) > **Boiler Relay**.
3. Tap **Next**.

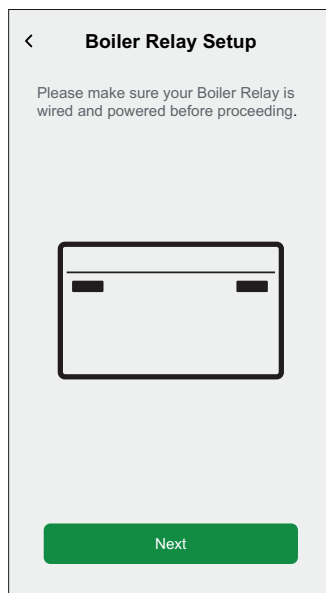

TIP: The next screen shows the joining process of the Boiler Relay.

4. Press and hold the Setup button for >2 s.

The Boiler Relay's LED flashes green and amber, then turns to solid green after successful joining to the Wiser system.

TIP: In case the device is failed to join LED shows solid red.

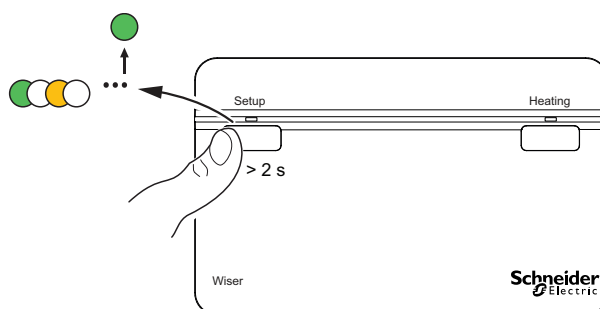

5. In the app, you can see the Boiler Relay is successfully joined.

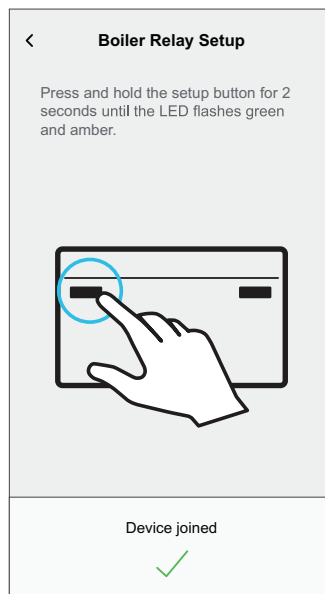

6. Enter the Boiler Relay name and tap **Next**.

7. On the **Boiler Relay Setup** page, select the **Control Type**:

- **Relay** , If Relay is selected, choose one of the following **Heat Source Type**:
 - **Gas Boiler** (Default)
 - **Electric Boiler**
 - **Oil Boiler**
 - **Heat Pump**
- **OpenTherm**, If selected OpenTherm (interfacing cable between Boiler Relay and Boiler) then the setup is completed.

TIP: Depending on the boiler interface choose the correct Relay or OpenTherm®.

You can see the paired Boiler Relay name and location on the Home page under the **All** devices or room tab.

Configuring the device

Renaming the device

Using the Wiser Home app, you can rename the Boiler Relay.

1. On the Home page, tap  icon.
2. Tap **Devices > Boiler Relay > Device Name (A)** to rename the Boiler Relay.

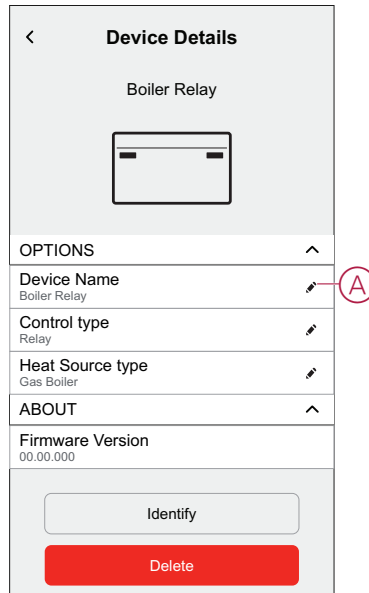

Setting the device control

Using the Wiser Home app, you can use set the control type such as Relay or OpenTherm.

Follow the below steps to set the control type:

1. On the Home page, tap  icon.

2. Tap **Devices > Boiler Relay > Control Type (A)** to select given option:

- **Relay**
- **OpenTherm**

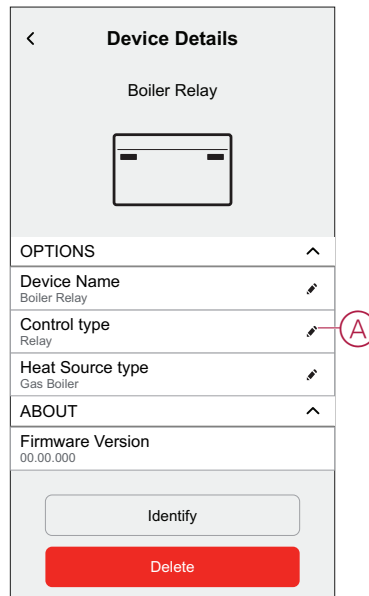

Setting heat source type

Using the Wiser Home app, you can set the heat source type such as Gas Boiler, Oil Boiler, Electric Boiler, or Heat Pump.

NOTE: Heat source type only required for relay channel.

Follow the below steps to set the heat source type.

1. On the Home page, tap  icon.
2. Tap **Devices > Boiler Relay > Heat Source Type (A)** to select given option:
 - **Gas Boiler** (Default)
 - **Oil Boiler**
 - **Electric Boiler**
 - **Heat Pump**

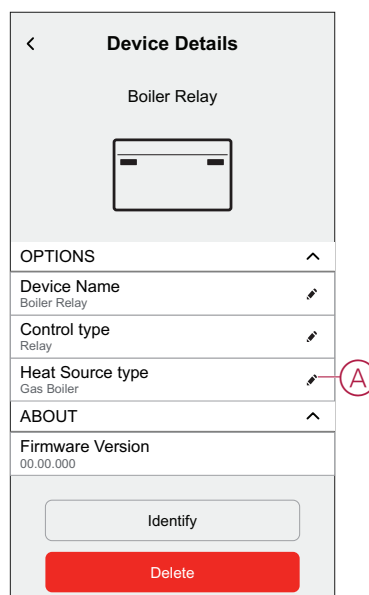

Identifying the device

Using the Wiser Home app, you can identify the Boiler Relay from the other available devices in the room.

Follow the below steps to identify the Boiler Relay:

1. On the Home page, tap  icon.
2. Tap **Devices > Boiler Relay > Identify (A)**.

NOTE:

- This feature flashes the Boiler Relay LEDs, so you can identify the actual device.
- The Boiler Relay LEDs will continue to flash green until you tap **OK**.

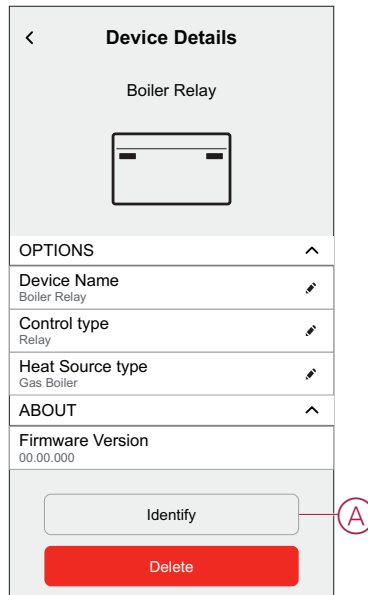

Removing the device

Using the Wiser Home app, you can remove the Boiler Relay from the Wiser system.

Follow the below steps to remove the Boiler Relay:

1. On the Home page, tap  icon.

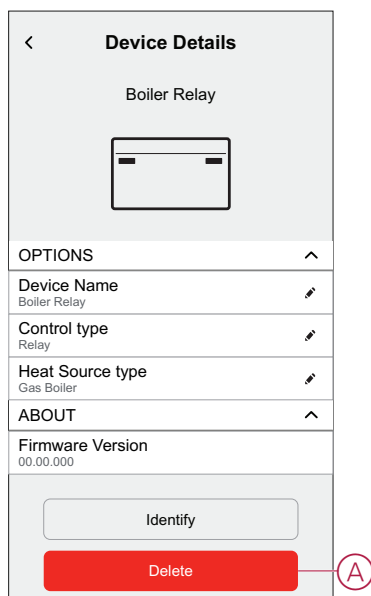
2. Tap **Devices > Boiler Relay > Delete** (A).3. In the next screen read the warning and tap **Delete**.

Resetting the device

You can reset the Boiler Relay to factory default mode.

Press and hold the setup button for >20 s.
After 15 seconds, the LED flashes red.

NOTE: The Boiler Relay is removed from the Wiser system and all function will be inactive until recommissioning.

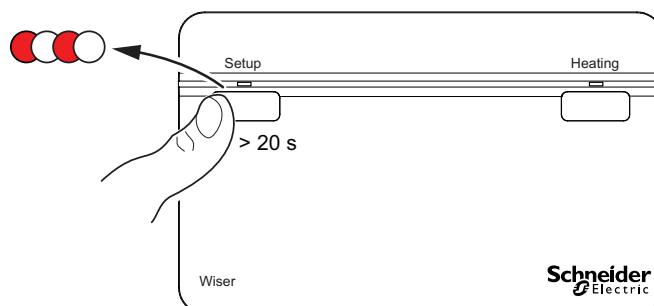

Using the device

Emergency heating

You can do an emergency heating by pressing the heating button on the Boiler Relay when the Hub is not working, or the Wiser Home app heating control is not responding.





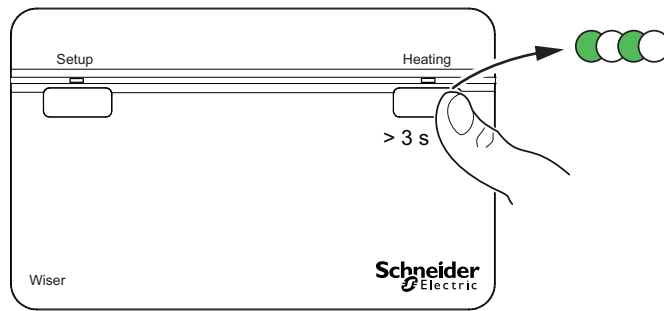



Press and hold the Heating button for >3 s.
When the heating override is active, the heating LED flashes green.

TIP: The heating is manually turned On for 2 hours. In this state, the boiler self-regulates its temperature. To turn off the override, press and hold the heating button for > 3 s the heating returns to system control.



LED indications

LED Indications

State	LED Indication	Status
Identify	All LEDs flash green 	The Boiler Relay is connected to the Wiser system. NOTE: This function is initiated from the app.
Joining to the Wiser system (Press and hold Boiler Relay setup button for >2 s)	Cycle between green and amber 	Initiates joining the Boiler Relay to a Wiser System.
Normal: Boiler ON	Solid green 	The Boiler Relay is powered On and heating is currently active.
Normal: Boiler OFF		The Boiler Relay is powered OFF and heating is currently inactive.
RF error	Solid amber 	The Boiler Relay is unable to communicate with the Wiser system. Refer to the Troubleshooting, page 16 to clear the RF error.
Digital boiler interface error	Solid red 	This indicates that the Boiler Relay is unable to communicate with the boiler via the digital interface. Refer to the Troubleshooting, page 16 to clear the digital boiler interface error.
Factory reset (Press and hold Boiler Relay setup button for >20 s)	Flashing red 	The boiler relay is in reset mode. The boiler relay then restarts and the LED blinks green and amber indicating that it is ready for pairing.
Emergency Heat / Test (Press and hold Boiler Relay setup button for >3 s)	Flashing green 	The heating is manually turned On for 2 hours.

Troubleshooting

Symptom	Possible cause	Solution
LED turns solid amber.	RF error in the Wiser System. The Boiler Relay is unable to communicate with the Wiser system.	Check that the Wiser Hub is powered On and in range of the Boiler Relay.
LED turns solid red.	Interface error in the Wiser System. The Boiler Relay is unable to communicate with the boiler via the digital interface.	Check that the boiler is powered On and that cables are connected between the boiler and the Boiler Relay.

Technical Data

Mains voltage:	AC 220-240 V, 50 Hz
Switch rating:	2 (1) A, AC 230 V total load max. 2,5 A
Wiring:	Fixed wiring only
User interface:	2x push button / LED
Wired interfaces:	1x Relay output, 1x Digital boiler interface, 1x Wiser Boiler Relay power supply
RF interface:	2.4 GHz (Bi-directional, Mesh)
Maximum RF power transmitted:	+17 dBm (50 mW)
Radio signal range:	30 m (free space)
Ambient temperature:	0 °C to 45 °C
Storage temperature:	-10 °C to 55 °C
Without mains power:	Display: LEDs off Interfaces: off
Mounting:	Industry standard wallplate
Dimensions (WxHxD):	93x148x31 mm

Compliance

Compliance information for Green Premium products

Find and download comprehensive information about Green Premium products, including RoHS compliance and REACH declarations as well as Product Environmental Profile (PEP) and End-of-Life instructions (EOLI).

General information about Green Premium products

Click the link below to read about Schneider Electric's Green Premium product strategy.

<https://www.schneider-electric.com/en/work/support/green-premium/>

Find compliance information for a Green Premium product

Click the link below to search for a product's compliance information (RoHS, REACH, PEP and EOLI).

NOTE: You will need the product reference number or product range to perform the search.

<https://www.reach.schneider-electric.com/CheckProduct.aspx?cskey=ot7n66yt63o1xblflyfj>

Trademarks

This guide makes reference to system and brand names that are trademarks of their relevant owners.

- Zigbee is a trademark of the Connectivity Standard Alliance™.
- Apple® and App Store® are brand names or registered trademarks of Apple Inc.
- Google Play™ Store and Android™ are brand names or registered trademarks of Google Inc.
- Wi-Fi® is a registered trademark of Wi-Fi Alliance®.
- Wiser™ is a trademark and the property of Schneider Electric, its subsidiaries and affiliated companies.

Other brands and registered trademarks are the property of their respective owners.

Schneider Electric
35 rue Joseph Monier
92500 Rueil Malmaison
France

+ 33 (0) 1 41 29 70 00

www.se.com

As standards, specifications, and design change from time to time,
please ask for confirmation of the information given in this publication.

© 2022 – Schneider Electric. All rights reserved.

DUG_Boiler Relay_WH-01