



# HL18T-N3A3AB

H18 Sure Sense

HYBRID PHOTOELECTRIC SENSORS

**SICK**  
Sensor Intelligence.

# HL18T-N3A3AB | H18 Sure Sense

HYBRID PHOTOELECTRIC SENSORS



Illustration may differ



## Ordering information

Type	Part no.
HL18T-N3A3AB	1082591

Other models and accessories → [www.sick.com/H18\\_Sure\\_Sense](http://www.sick.com/H18_Sure_Sense)

## Detailed technical data

### Features

<b>Functional principle</b>	Photoelectric retro-reflective sensor
<b>Functional principle detail</b>	Dual lens
<b>Dimensions (W x H x D)</b>	16.2 mm x 44.9 mm x 31.8 mm
<b>Housing design (light emission)</b>	Hybrid
<b>Thread diameter (housing)</b>	M18
<b>Mounting system type</b>	M18, head/side (24.1 ... 25.4 mm)
<b>Housing color</b>	Blue
<b>Sensing range max.</b>	0.1 m ... 3 m <sup>1)</sup>
<b>Sensing range</b>	0.1 m ... 2.5 m <sup>1)</sup>
<b>Type of light</b>	Visible red light
<b>Light source</b>	PinPoint LED <sup>2)</sup>
<b>Light spot size (distance)</b>	60 mm x 120 mm (3 m)
<b>Wave length</b>	631 nm
<b>Adjustment</b>	
	Potentiometer, right Sensitivity
	Potentiometer, left None
<b>Special applications</b>	Detecting transparent objects
<b>Special features</b>	-

<sup>1)</sup> Reflector PL80A.

<sup>2)</sup> Average service life: 100,000 h at T<sub>J</sub> = +25 °C.

## Mechanics/electronics

<b>Supply voltage</b>	10 V DC ... 30 V DC
<b>Ripple</b>	$< 5 V_{pp}^{1)}$
<b>Current consumption</b>	$\leq 20 \text{ mA}^{2)}$
<b>Switching output</b>	NPN
<b>Output function</b>	Complementary
<b>Switching mode</b>	Light/dark switching
<b>Switching output detail</b>	
Switching output Q1	NPN, Light switching
Switching output Q2	NPN, Dark switching
<b>Output current <math>I_{max}</math></b>	$\leq 100 \text{ mA}$
<b>Response time</b>	$\leq 0.5 \text{ ms}^{3)}$
<b>Switching frequency</b>	$1,000 \text{ Hz}^{4)}$
<b>Connection type</b>	Male connector M8, 4-pin
<b>Circuit protection</b>	A <sup>5)</sup> B <sup>6)</sup> D <sup>7)</sup>
<b>Protection class</b>	III
<b>Weight</b>	18 g
<b>Polarisation filter</b>	✓
<b>Housing material</b>	Plastic, VISTAL®
<b>Optics material</b>	Plastic, PMMA
<b>Enclosure rating</b>	IP67 IP69K
<b>Items supplied</b>	Fastening nut (1x), M18, plastic, black, flat
<b>Electromagnetic compatibility (EMC)</b>	EN 60947-5-2 (The sensor complies with the Radio Safety Requirements (EMC) for the industrial sector (Radio Safety Class A). It may cause radio interference if used in a residential area.)
<b>Ambient operating temperature</b>	$-40 \text{ °C} \dots +70 \text{ °C}$
<b>Ambient temperature, storage</b>	$-40 \text{ °C} \dots +75 \text{ °C}$
<b>UL File No.</b>	E189383

<sup>1)</sup> May not exceed or fall below  $U_v$  tolerances.

<sup>2)</sup> Without signal strength light bar and load.

<sup>3)</sup> Signal transit time with resistive load.

<sup>4)</sup> With light/dark ratio 1:1.

<sup>5)</sup> A =  $V_S$  connections reverse-polarity protected.

<sup>6)</sup> B = inputs and output reverse-polarity protected.

<sup>7)</sup> D = outputs overcurrent and short-circuit protected.

## Safety-related parameters

<b>MTTF<sub>D</sub></b>	936.1 years
<b>DC<sub>avg</sub></b>	0 %

## Classifications

<b>ECLASS 5.0</b>	27270902
<b>ECLASS 5.1.4</b>	27270902

<b>ECLASS 6.0</b>	27270902
<b>ECLASS 6.2</b>	27270902
<b>ECLASS 7.0</b>	27270902
<b>ECLASS 8.0</b>	27270902
<b>ECLASS 8.1</b>	27270902
<b>ECLASS 9.0</b>	27270902
<b>ECLASS 10.0</b>	27270902
<b>ECLASS 11.0</b>	27270902
<b>ECLASS 12.0</b>	27270902
<b>ETIM 5.0</b>	EC002717
<b>ETIM 6.0</b>	EC002717
<b>ETIM 7.0</b>	EC002717
<b>ETIM 8.0</b>	EC002717
<b>UNSPSC 16.0901</b>	39121528

### Connection type/pinouts

<b>Connection type</b>	Male connector M8, 4-pin
<b>Pinouts</b>	
BN 1	+ (L+)
WH 2	Q <sub>2</sub>
BU 3	- (M)
BK 4	Q <sub>1</sub>

**Dimensional drawing** (Dimensions in mm (inch))

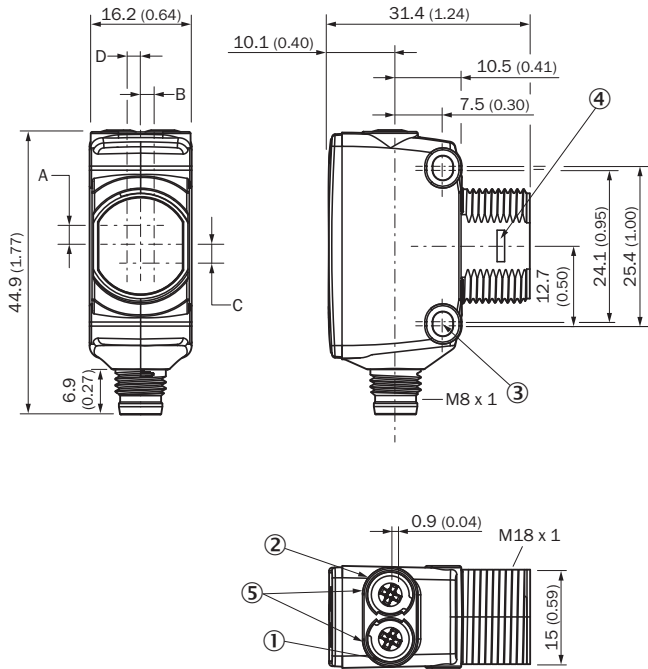

- ① LED indicator yellow: Status of received light beam
- ② LED indicator green: power on
- ③ M3 mounting hole
- ④ Snap Connection for flush ring (sold seperatly)
- ⑤ Potentiometer (if selected) or LED Indicators

Dimensions in mm (inch)	Receiver		Sender	
	A	B	C	D
<b>HTB18 / HTF18</b>	- 1.1 (0.04)	1.1 (0.04)	4.7 (0.19)	0.6 (0.02)
<b>HTE18 / HL18 / HSE18</b>	2.5 (0.1)	0.0 (0.0)	4.0 (0.16)	0.0 (0.0)
<b>HTB18L / HTF18L / HL18L / HSE18L</b>	2.5 (0.1)	0.0 (0.0)	3.5 (0.14)	0.0 (0.0)

**Connection type**

Pinouts, see Technical details: **Connection type/pinouts**

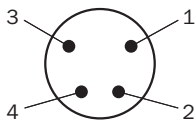

Male connector, M8, 4-pin, uncoded

### Characteristic curve

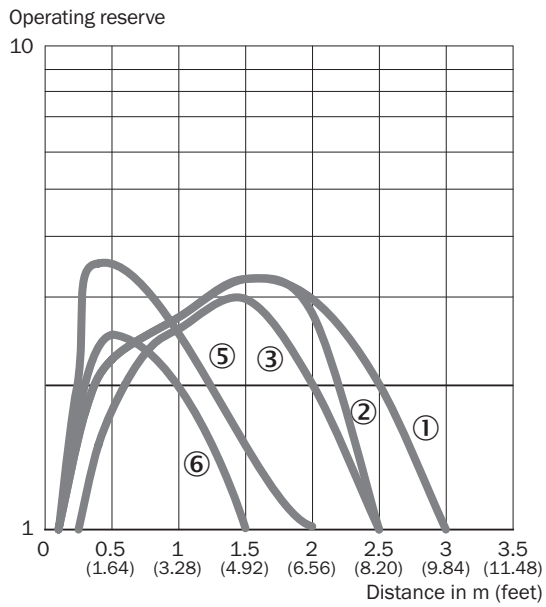

- ① Reflector PL80A
- ② Reflector PL40A
- ③ Reflector P250F
- ⑤ Reflective tape REF-AC1000
- ⑥ Reflector PL41F

### Light spot size

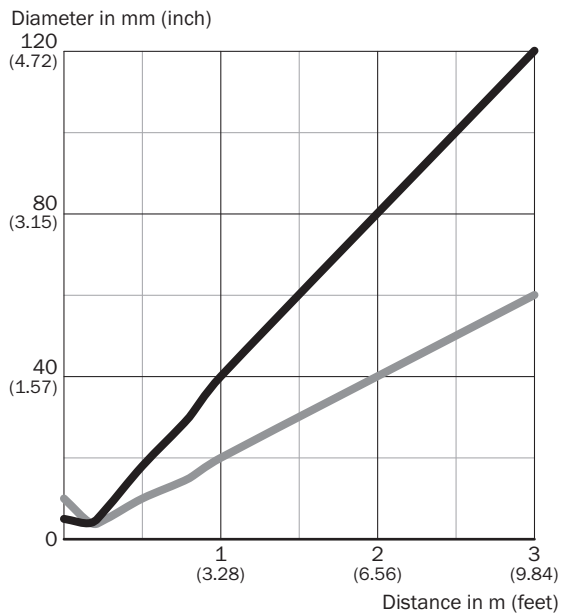

#### Dimensions in mm (inch)

Sensing range	Vertical	Horizontal
<b>0.5 m</b> (1.64 feet)	18 (0.71)	10 (0.39)
<b>0.8 m</b> (2.62 feet)	30 (1.18)	15 (0.59)
<b>1 m</b> (3.28 feet)	40 (1.57)	20 (0.79)
<b>3 m</b> (9.84 feet)	120 (4.72)	60 (2.36)

- Vertical
- Horizontal

### Sensing range diagram

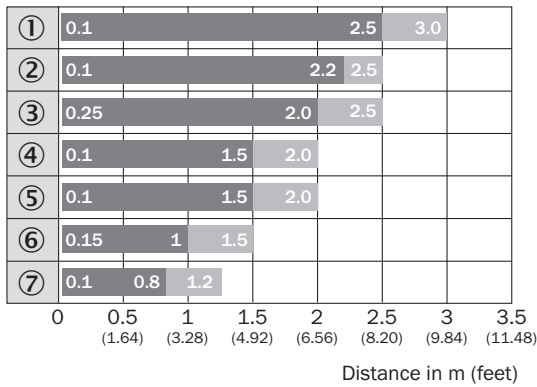

■ Sensing range      ■ Sensing range max.

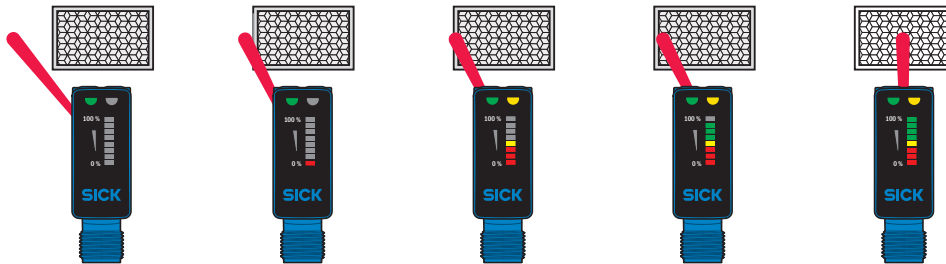

- ① Reflector PL80A
- ② Reflector PL40A
- ③ Reflector P250F
- ④ Reflector PL30A, PL31A
- ⑤ Reflective tape REF-AC1000
- ⑥ Reflector PL41F
- ⑦ Reflector PL20A

### Functions





### Recommended accessories

Other models and accessories → [www.sick.com/H18\\_Sure\\_Sense](http://www.sick.com/H18_Sure_Sense)

	Brief description	Type	Part no.
<b>Mounting brackets and plates</b>			
	Universal mounting bracket for reflectors, steel, zinc coated	BEF-WN-REFX	2064574
<b>Plug connectors and cables</b>			
	<ul style="list-style-type: none"> <li>• <b>Connection type head A:</b> Male connector, M8, 4-pin, straight</li> <li>• <b>Description:</b> Unshielded</li> <li>• <b>Connection systems:</b> Screw-type terminals</li> <li>• <b>Permitted cross-section:</b> 0.14 mm<sup>2</sup> ... 0.5 mm<sup>2</sup></li> </ul>	STE-0804-G	6037323

# HL18T-N3A3AB | H18 Sure Sense

## HYBRID PHOTOELECTRIC SENSORS

	Brief description	Type	Part no.
Reflectors			
	Rectangular, screw connection, 51 mm x 61 mm, PMMA/ABS, Screw-on, 2 hole mounting	P250	5304812
Others			
	<ul style="list-style-type: none"><li>• <b>Connection type head A:</b> Female connector, M8, 4-pin, straight, A-coded</li><li>• <b>Connection type head B:</b> Flying leads</li><li>• <b>Signal type:</b> Sensor/actuator cable</li><li>• <b>Cable:</b> 5 m, 4-wire, PVC</li><li>• <b>Description:</b> Sensor/actuator cable, unshielded</li><li>• <b>Application:</b> Zones with chemicals</li></ul>	YF8U14-050VA3XLEAX	2095889



## SICK AT A GLANCE

SICK is one of the leading manufacturers of intelligent sensors and sensor solutions for industrial applications. A unique range of products and services creates the perfect basis for controlling processes securely and efficiently, protecting individuals from accidents and preventing damage to the environment.

We have extensive experience in a wide range of industries and understand their processes and requirements. With intelligent sensors, we can deliver exactly what our customers need. In application centers in Europe, Asia and North America, system solutions are tested and optimized in accordance with customer specifications. All this makes us a reliable supplier and development partner.

Comprehensive services complete our offering: SICK LifeTime Services provide support throughout the machine life cycle and ensure safety and productivity.

For us, that is “Sensor Intelligence.”

## WORLDWIDE PRESENCE:

Contacts and other locations –[www.sick.com](http://www.sick.com)